



User manual

Direct-Current Frequency Conversion Heater

AWH9/11/13-V5+



★ Before operating this product, please read the instruction carefully and keep this manual for future use!

1.Before use

1.1 List of accessories	3
1.2 Symbol description	3
1.3 Safety precautions	3
1.4 Features and advantages	6
1.5 Specifications	7
1.6 Part name	9
1.7 Working principle	11
1.8 Water pump	11

2.Installation

2.1 Installation methods	13
2.2 Necessary tools for installation	14
2.3 Installation precautions	15
2.4 Installation of indoor unit	16
2.5 Outdoor unit installation	17
2.6 Wiring	18
2.7 Connection of refrigerant pipe	22
2.8 Installation of air purging valve	25
2.9 Water pipe connection	26
2.10 Air purging	27
2.11 Test run	28

3.Useage

3.1 Introduction of operation panel	29
3.2 Parameter Setting Overview	31
3.3 Basic Operation	36
3.4 Advanced Setting	48
3.5 Failure code	58
3.6 Error code	59

4.Maintenance

4.1 Attention	65
4.2 Cleaning of water filter	65
4.3 Cleaning of plate heat exchanger	65
4.4 Gas charging	66
4.5 Condenser coil	67
4.6 Service of outdoor unit	67
4.7 Trouble shooting	71

5.Appendix

5.1 Outlines and dimensions	73
5.2 Exploded view	75
3.3 Wiring diagram	79

1. BEFORE USE



Attention

Thank you for choosing the product. In order to operate this product well and to prevent accidents due to misoperation, please read carefully this user manual before carrying out any installation or operation. Please pay special attention to the warning, prohibition and attention instructions. We will continuously upgrade this user manual for better service !

1.1 List of accessories

The accessories below are delivered together with the product .

Please check in time. If there is any shortage or damage, please contact local distributor.

Name	Quantity
Sealing ring	2
Expansion bolt	2
Screw	12
5m extension cable for sensor TH/TC/TW	3
12m extension cable for sensor TR	1
Plastic casing for sensor TR	1
Plastic casing for sensor TR	1
User manual	1
Copper pipe connected to pressure release valve	1
Mounting plate	1
Pressure release valve	1
Copper nut	1
Connector for pressure release valve	1
10m signal cable between indoor and outdoor unit	1

1.2 Symbol description

The following symbols are very important. Please be sure to understand their meaning, which concerns the product and your personal safety.



Warning



Caution



Prohibition

1.3 Safety precautions



This appliance is not intended for use by persons, including children, with reduced physical, sensory or mental capabilities, or lack of experience and knowledge, unless they have been given supervision or instruction concerning use of the appliance by a person responsible for their safety. Children should be supervised to ensure that they do not play with the appliance.

1. BEFORE USE

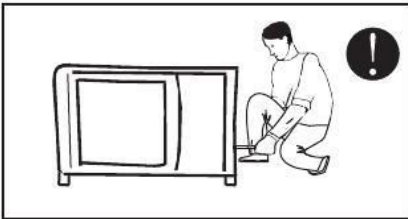

The installation, dismantlement and maintenance of the unit must be performed by qualified personnel. It is forbidden to do any changes to the structure of the unit. Otherwise injury of person or unit damage might happen.

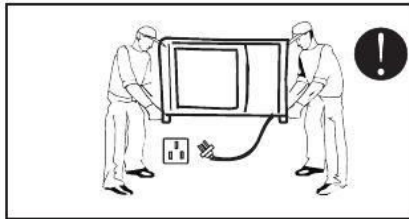

Make sure the power supply to the heat pump unit is off before any operations are done on the unit.

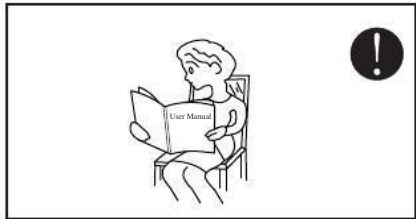

Be sure to read this manual before use.

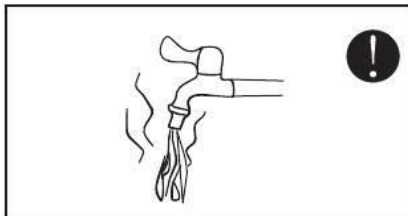

Before taking shower, please always add a mixture valve before water tap and set it to proper temperature.

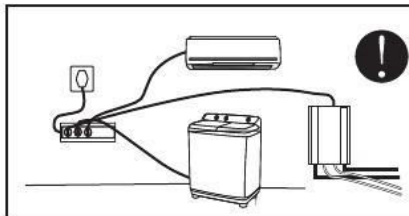

Use a dedicated socket for this unit, otherwise malfunction may occur.

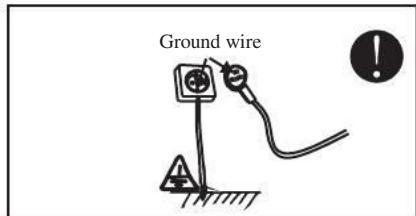

The power supply to the unit must be grounded.

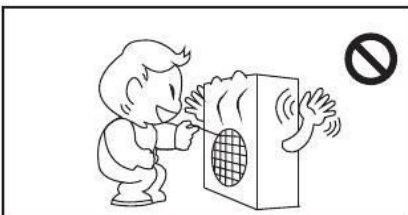

Do not touch the air outlet grill when fan motor is running.

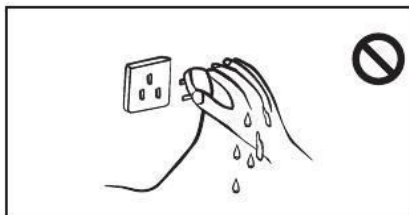

Do not touch the power plug with wet hands. Never pull out the plug by pulling the power cable.

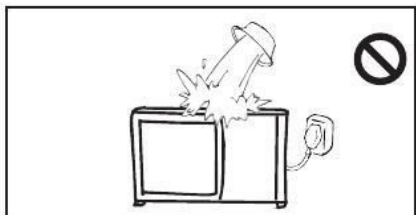

Water or any kind of liquid is strictly forbidden to be poured into the product, or may cause creepage or breakdown of the product.

1. BEFORE USE

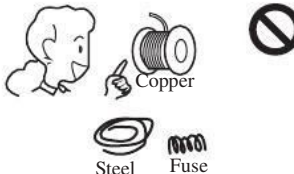
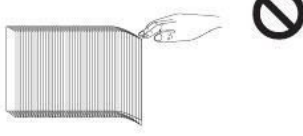
		
<p>When the power cord gets loose or is damaged, always get a qualified person to fix it.</p>	<p>Please select the correct fuse or breaker as per recommended. Steel wire or copper wire cannot be taken as substitute for fuse or breaker. Otherwise, damaged maybe caused.</p>	<p>Be aware finger might be hurt by the fin of the coil.</p>

		
<p>It is mandatory to use a suitable circuit breaker for the heat pump and make sure the power supply to the heater corresponds to the specifications. Otherwise the unit might be damaged.</p>	<p>Disposal of Scrap Batteries --- collection point. Please discard the batteries as sorted municipal waste at the accessible</p>	<p>Installation of a residual current device (RCD) having a rated residual operating current not exceeding 30 mA is advisable.</p>



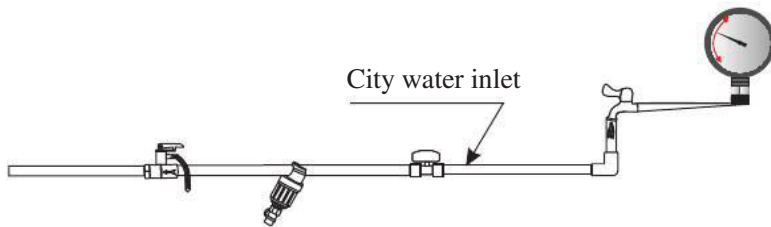

The maximum inlet water pressure, in pascals: 0.7Mpa.
The minimum inlet water pressure, in pascals, if this is necessary for the correct operation of the appliance: 0.1Mpa.

1. BEFORE USE

1.4 Features and advantaged

★ This unit using the latest DC inverter technology.It can adjust its working frequency,so to give out its output according to the loading.It can work down to -25°C with good COP.

★ The unit is designed with easy installation that no refrigerant charging or copper pipe brazing is required on site.It can be widely used in house and villa.

★ The unit is with environment-friendly refrigerant R410A,which also provides one of the highest energy efficiency ratings in the industry.Output of the compressor and therefore the energy input requirements are constantly monitored and adjusted at the most optimum level for the given indoor and outdoor environmental conditions,and the user's desired demands from the system.

★ Microprocessor control system contains several enhanced software features to make the operation of the system most advantageous and pleasing,under varying environmental conditions.

★ Special vibration absorbers on the compressor allow operation of the system with ultra low noise.

★ Microprocessor is programmed to allow operation under wide range of input voltages from 160V-260V and soft starting with lower current draw at each compressor start-up.

★ Auto-restart function keeps all settings in memory and automatically resumes the operation after a power failure.

★ Compressor crankcase heater and bottom plate heater are available as options for extreme cold conditions,enabling the unit to work in very low ambient temperatures with much lessened defrost frequencies,Both these optional heaters are electronically controlled based on the outdoor ambient temperatures and a sophisticated logic.

★ Programmable timer function provides unattended operation of the system.

★ Acrylic coated enhanced aluminum fins on the coil heat exchanger extends the fin life against corrosion and allows easier rainwater wash-down as well as faster defrosts.

★ Copper tubing in all heat exchangers are made by the latest developments in the technology of inner grooved tubing by extending the area of heat exchange in a more compact coil,therefore increasing the operational efficiency.

1. BEFORE USE

1.5 Specifications

Type of Product	DC Inverter Air to Water Heat Pump Unit				
Model		AWH9-V5+			
Power Supply	V/Hz/Ph	220-240/50/1			
Refrigerant	Kg	R410A/1.9	R410A/1.9	R410A/3.5	
Max. Heating Capacity (1)	KW	10.10	11.5	12.6	
C.O.P (1)	W/W	4.03	3.91	4	
Heating Capacity Min./Max.(1)	KW	4.33/10.10	4.67/11.5	4.2/12.6	
Heating Power Input Min./Max.(1)	W	975/2153	815/2928	896/3160	
C.O.P Min./Max.(1)	W/W	4.02/4.65	3.9/5.73	4.0/4.91	
Max. Heating Capacity(2)	KW	9.53	10.7	11.5	
C.O.P (2)	W/W	3.17	3.03	3.11	
Heating Capacity Min./Max.(2)	KW	4.19/9.53	4.14/10.7	3.76/11.5	
Heating power input Min./Max.(2)	W	1230/2990	1120/3520	1237/3693	
C.O.P Min./Max.(2)	W/W	3.12/3.55	3.04/3.69	3.10/3.33	
Max. Cooling Capacity(3)	KW	6.84	8.4	10.3	
E.E.R (3)	W/W	2.09	2.8	3.32	
Cooling Capacity Min./Max.(3)	KW	4.10/6.84	2.39/8.4	4.29/10.37	
Cooling Power Input Min./Max.(3)	W	1230/3280	890/3300	926/3126	
E.E.R Min./Max.(3)	W/W	2.09/3.32	2.545/3.3	3.32/4.74	
Max. Cooling Capacity(4)	KW	5.05	6.74	7.9	
E.E.R(4)	W/W	1.58	2.24	2.65	
Cooling Capacity Min./Max.(4)	KW	2.34/5.05	2.17/6.74	2.34/7.91	
Cooling Power Input Min./Max.(4)	W	1080/3200	827/3032	974/2982	
E.E.R Min./Max.(4)	W/W	1.58/2.40	2.22/3.0	2.40/3.03	
Circuit Max. Pressure	bar	42			
Rated Power Water Pump	W	87			
Compressor	Type	Twin Rotary			
	Quantity/System	1			
	Oil	FV50S			
	Quantity	1	1	2	
	Quantity	m ³ /h	3000	3100	4100
Fan	Airflow	W	60		
Allowable	Face Area	m ²	0.542	0.871	1.5
Fan Flow	Rated Power	2 Rows-14			
	Row-Fins/Inch	3/8 O.D			
	Tube.Dia	Inch			
		dB (A)			
		30/56			

Noise Level Indoor/Outdoor

AWH11-V5+

1. BEFORE USE

Type of Product		DC Inverter Air to Water Heat Pump Unit			
Model		AWH9-V5+			
Water Side Heat Exchanger	Type	Plate Heat Exchanger			
	Material	Stainless Steel+Copper			
	Water Pressure Drop	Kpa	23	23	26
	Piping Connection	Inch	G1"		
Allowable Water Flow	Min. Water Flow		0.26	0.31	0.37
	Rated Water Flow	L/S	0.43	0.52	0.61
	Max. Water Flow		0.51	0.62	0.73
Net Dimension (L×D×H)	Outdoor Unit	mm	934×354×753	1044×414×763	1124×460×1195
	Indoor Unit	mm	580×380×256.7		
Packing Dimension (L×D×H)	Outdoor Unit	mm	990×440×810	1140×490×810	1160×490×1355
	Indoor Unit	mm	695×450×315		
Net Weight	Outdoor Unit	Kg	62.5	75	113
	Indoor Unit	Kg	23		
Packing Weight	Outdoor Unit	Kg	72.5	80	123
	Indoor Unit	Kg	28		
Operating Ambient Temp. range	Heating	°C	-25~45		
	Cooling	°C	0~55		
Operating Inlet Water Temp. range		°C	10~50		
Water Volume		Kg	4.5		

NOTE:

AWH13-V5+

- (1) Heating condition: water in/out temperature:30°C/35°C, ambient temperature:DB/WB 7/6°C;
- (2) Heating condition: water in/out temperature:40°C/45°C, ambient temperature:DB/WB 7/6°C;
- (3) Cooling condition: water in/out temperature:23°C/18°C, ambient temperature:35°C;
- (4) Cooling condition: water in/out temperature:12°C/7°C, ambient temperature:35°C.
- (5) The specifications are subject to change without prior notice.

For actual specifications of the unit, please refer to the specification stickers on the unit.

1. BEFORE USE

1.6 Part name

AWH9/11/13-V5+

Indoor

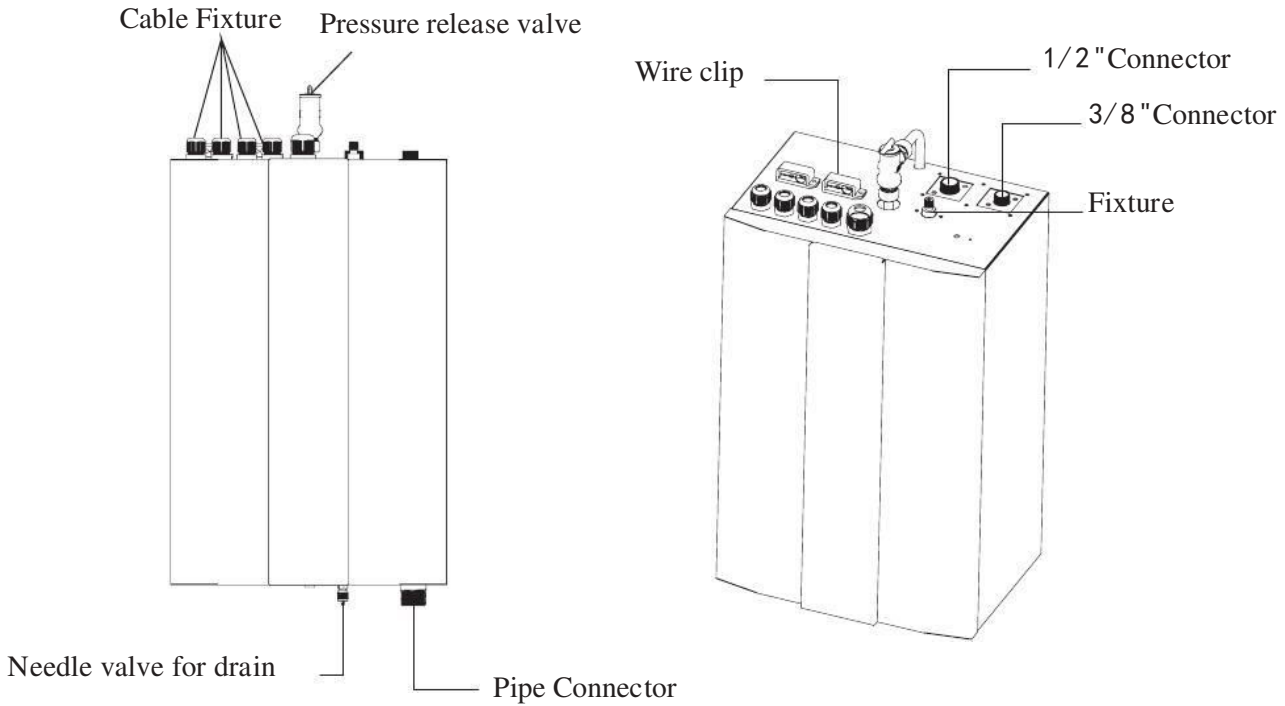

AW9/11-V5+

Outdoor

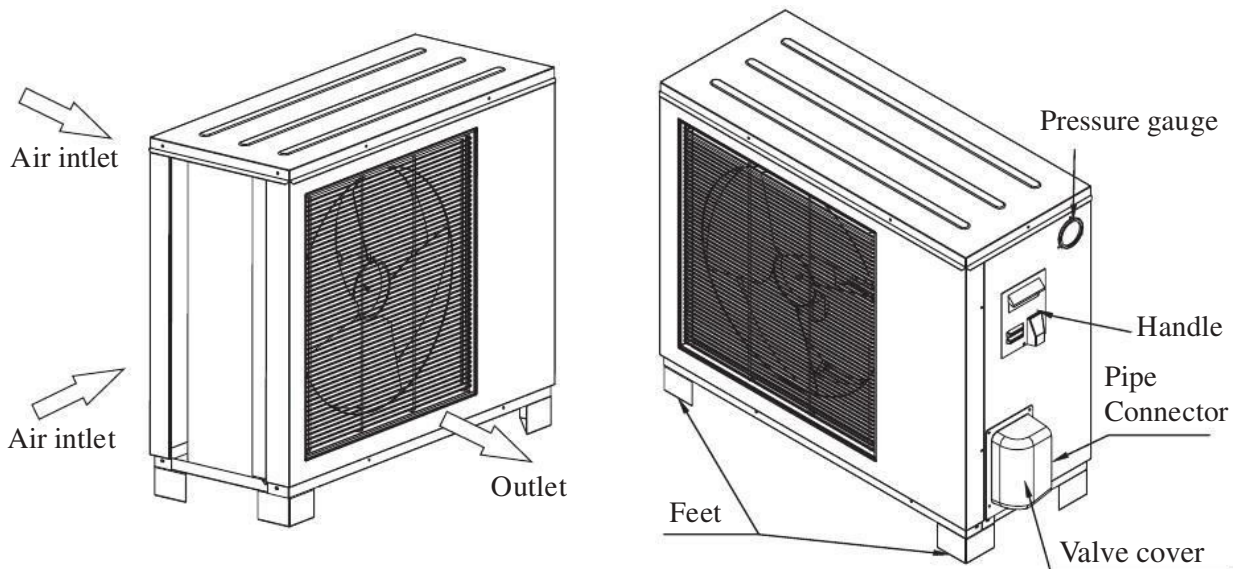

1. BEFORE USE

AW13-V5+

Outdoor

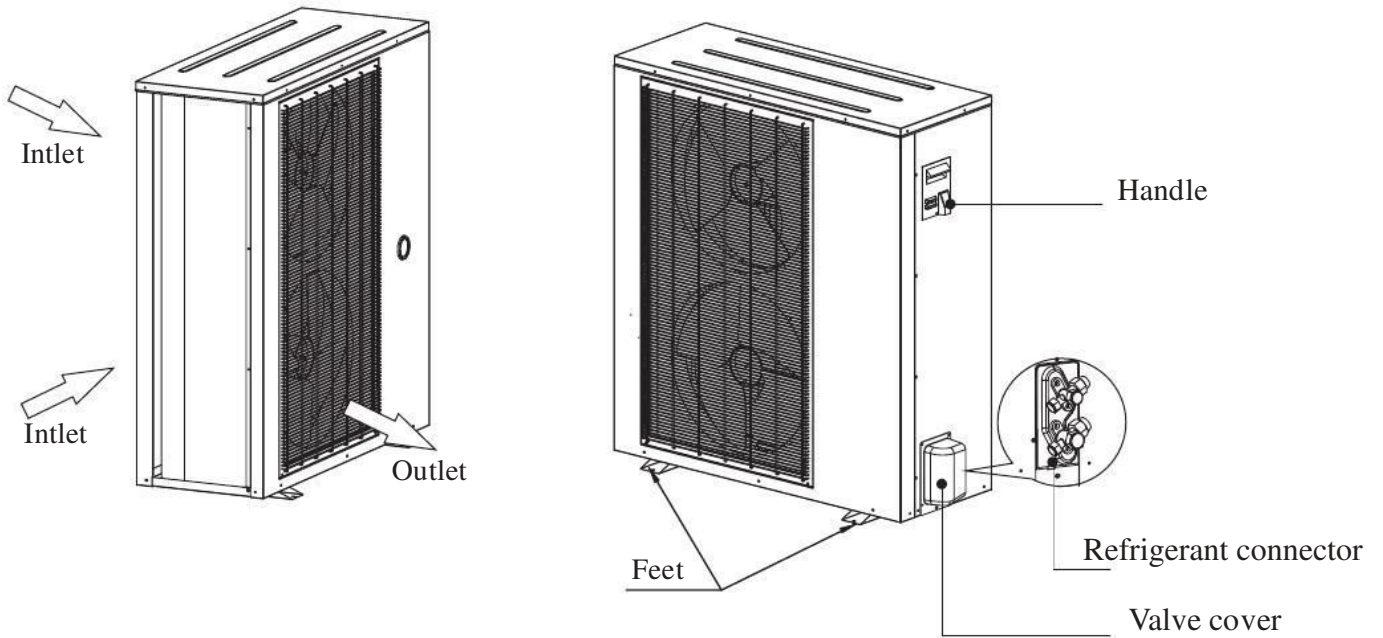

1. BEFORE USE

1.7 Working principle

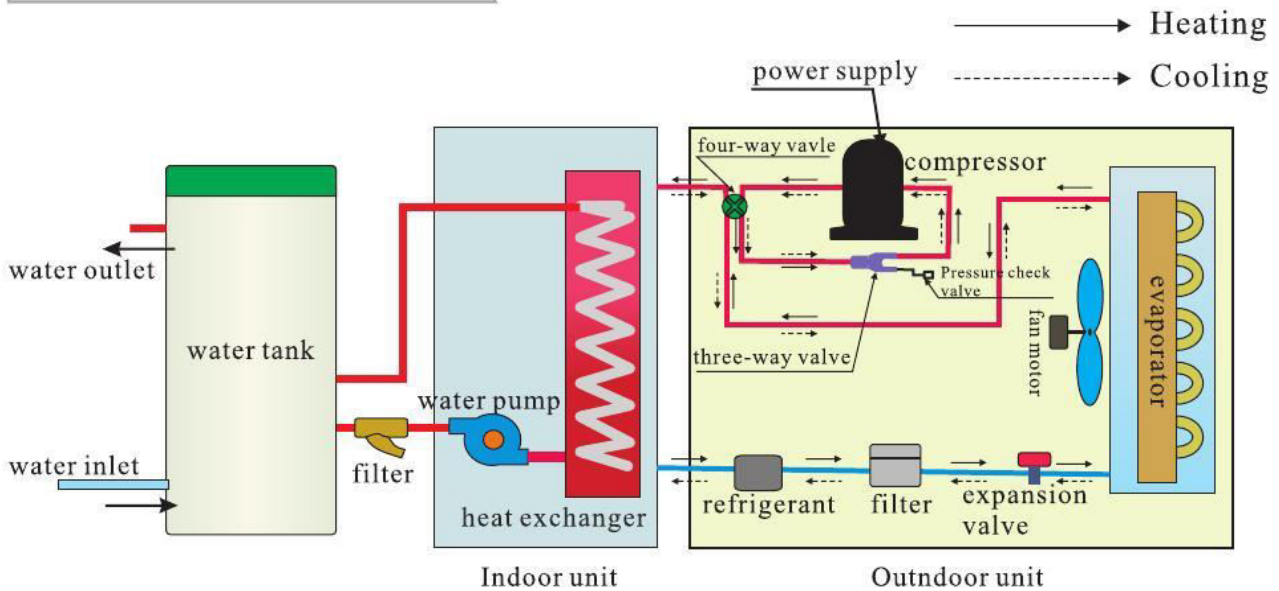

1.8 Water pump

Setting the pump speed

The pump speed can be selected on the pump. The default setting is highest speed. If the water flow in the system is too high (e.g. noise of running water in the installation) the speed can be lowered.

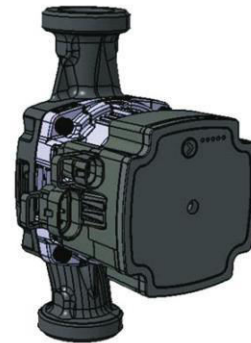
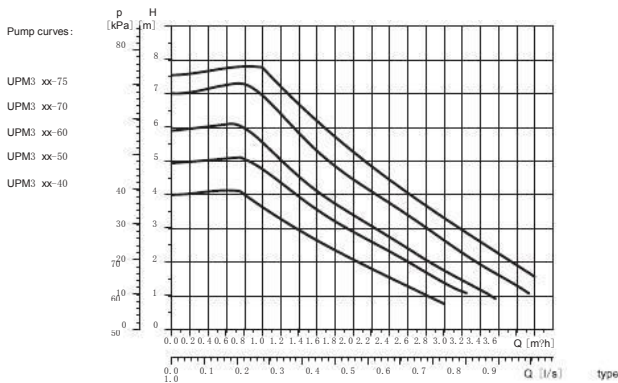

User interface

The user interface is designed with a single push button, one red/green LED and four yellow LEDs.

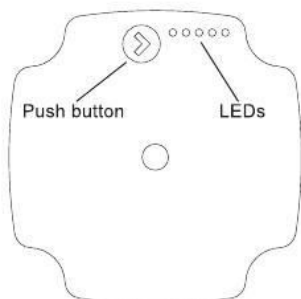

TM06 0535 0414

The user interface shows:

- performance view (during operation)
 - operation status
 - alarm status
- settings view (after pressing the button).

During operation, the display shows the performance view. If you press the button, the user interface switches the view or runs in the setting selection mode.

Fig. 10 User interface with one push button and five LEDs

1. BEFORE USE

Performance view

The performance view shows either the operation status or the alarm status.

Operation status

When the circulator is running, LED 1 is green. The four yellow LEDs indicate the current power consumption (P1) as shown in the table below. See fig. 11. When the operation mode is active, all active LEDs are constantly on in order to differentiate this mode from the select setting mode. If the circulator is stopped by an external signal, LED 1 flashes green.

Display	Indication	Performance in % of P1 MAX
One green LED (flashing)	Standby (only externally controlled)	0
One green LED + one yellow LED	Low performance	0-25
One green LED + two yellow LED	Medium low performance	25-50
One green LED + three yellow LED	Medium high performance	50-75
One green LED + four yellow LED	High performance	75-100

Operation area

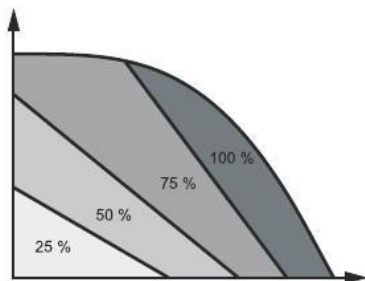

Fig. 11 Operation area according to performance load

Alarm status

If the circulator has detected one or more alarms, the bi-colored LED 1 switches from green to red. When an alarm is active, the LEDs indicate the alarm type as defined in the table below. If multiple alarms are active at the same time, the LEDs only show the error with the highest priority. The priority is defined by the sequence of the table.

When there is no active alarm anymore, the user interface switches back to operation mode.

Display	Indication	Pump operation	Counter action
One red LED + one yellow LED (LED 5)	Rotor is blocked.	Trying to start again every 1.33 seconds.	Wait or deblock the shaft.
One red LED + one yellow LED (LED 4)	Supply voltage too low.	Only warning, pump runs.	Control the supply voltage.
One red LED + one yellow LED (LED 3)	Electrical error.	Pump is stopped because of low supply voltage or serious failure.	Control the supply voltage / Exchange the pump.

Settings view

You can switch from the performance view to the settings view by pressing the push button. The LEDs indicate the actual setting. The settings view shows which mode controls the circulator. No settings can be made at this stage. After 2 seconds, the display switches back to performance view.

If LED 1 is green, it indicates operation or internal control. If LED 1 is red, it indicates alarm or external control. LED 2 and 3 indicate the different control modes and LED 4 and 5 indicate the different curves.

	LED 1	LED 2	LED 3	LED 4	LED 5
Proportional pressure	green	•			
Constant pressure	green		•		
Constant curve	green	•	•		
PWM A profile	red	•			
PWM B profile	red		•		
Curve 1				•	
Curve 2				•	•
Curve 3				•	•
Curve 4/AUTO _{ADAPT}					•

Note: • = The LED is yellow.

Setting selection

You can choose between the performance view and settings view.

If you press the button for 2 to 10 seconds, the user interface switches to "setting selection" if the user interface is unlocked. You can change the settings as they appear. The settings appear in a particular order in a closed loop. When you release the button, the user interface switches back to the performance view and the last setting is stored.

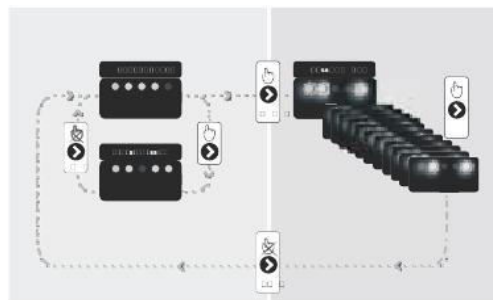
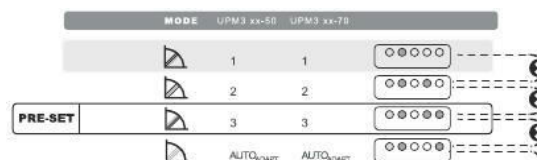

Fig. 12 Setting selection

Settings navigation



2. INSTALLATION

2.1 Installation methods

Application1: This installation is for supplying sanitary hot water only.

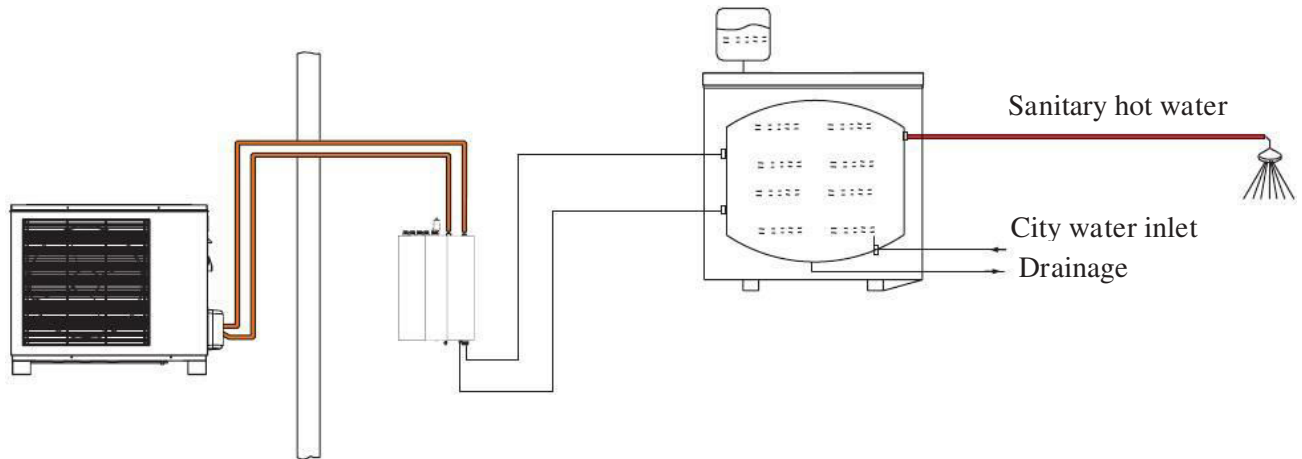

Application2: This installation is for supplying floor heating hot water only.

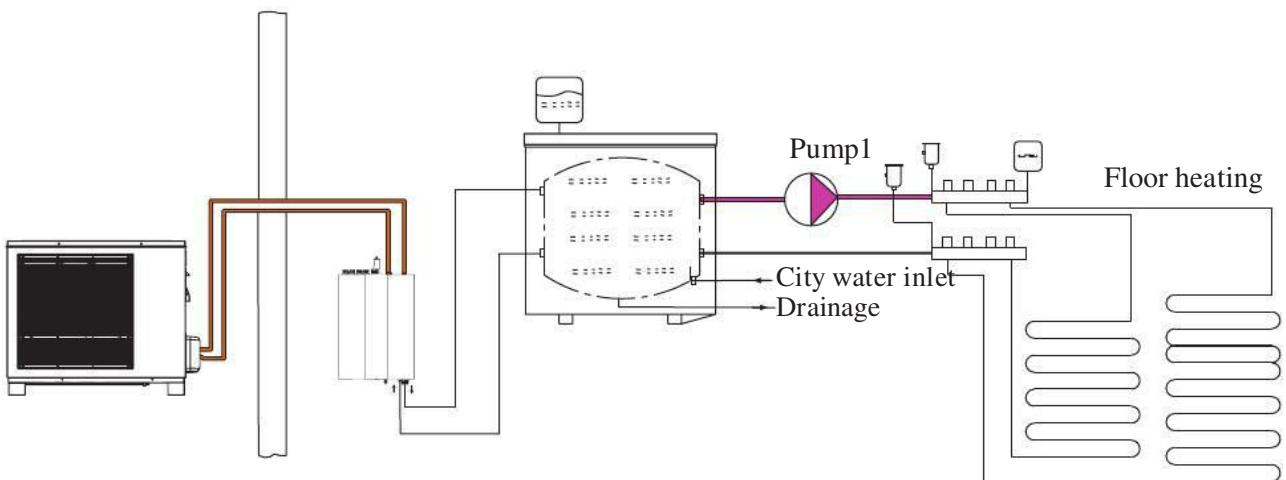

Application 3: It provides both floor heating hot water and pre-heated sanitary water.

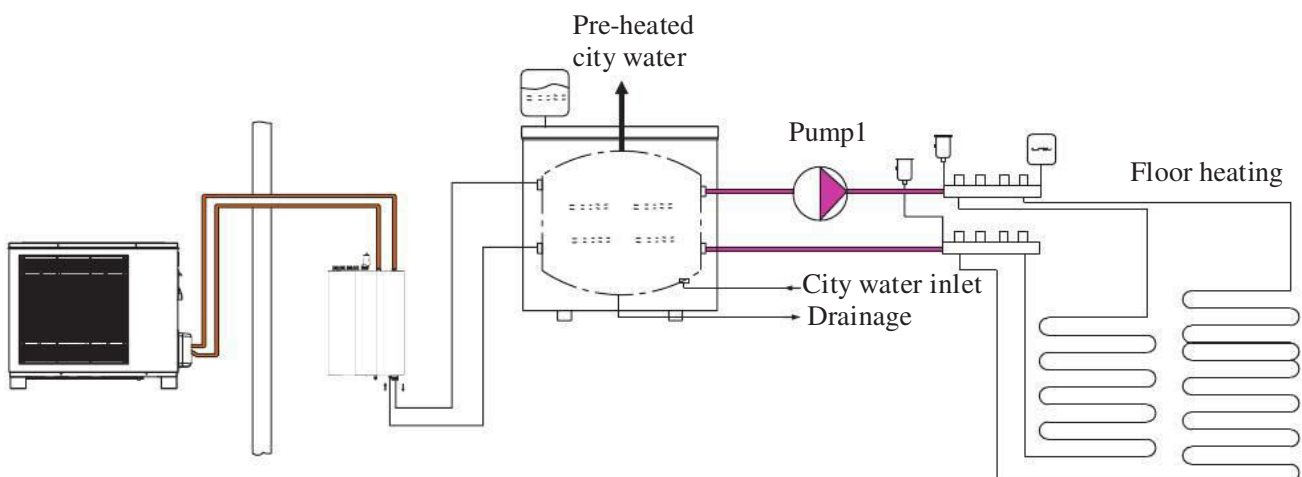

2. INSTALLATION

Application4:It provides hot water for central house heating and hot water system.

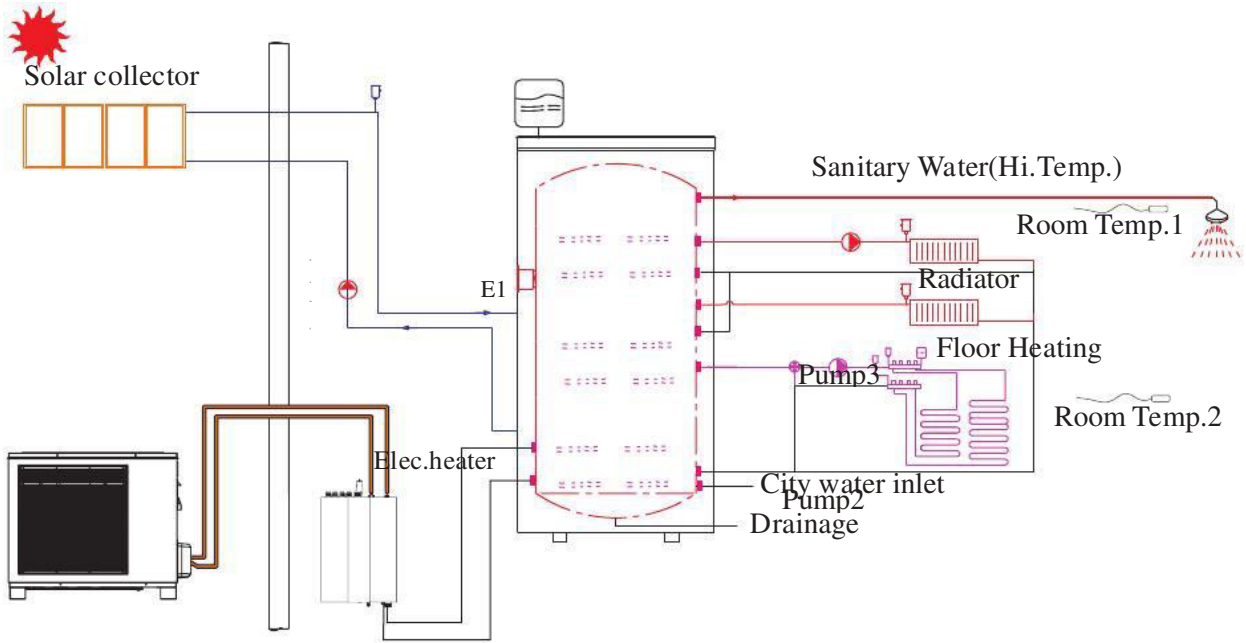

Heat Pump and Solar System for Heating&Sanitary Water

2.2 Necessary tool for installation



tapeline



screw driver



drill



Spanner



Scissors

2. INSTALLATION

2.3 Installation precautions

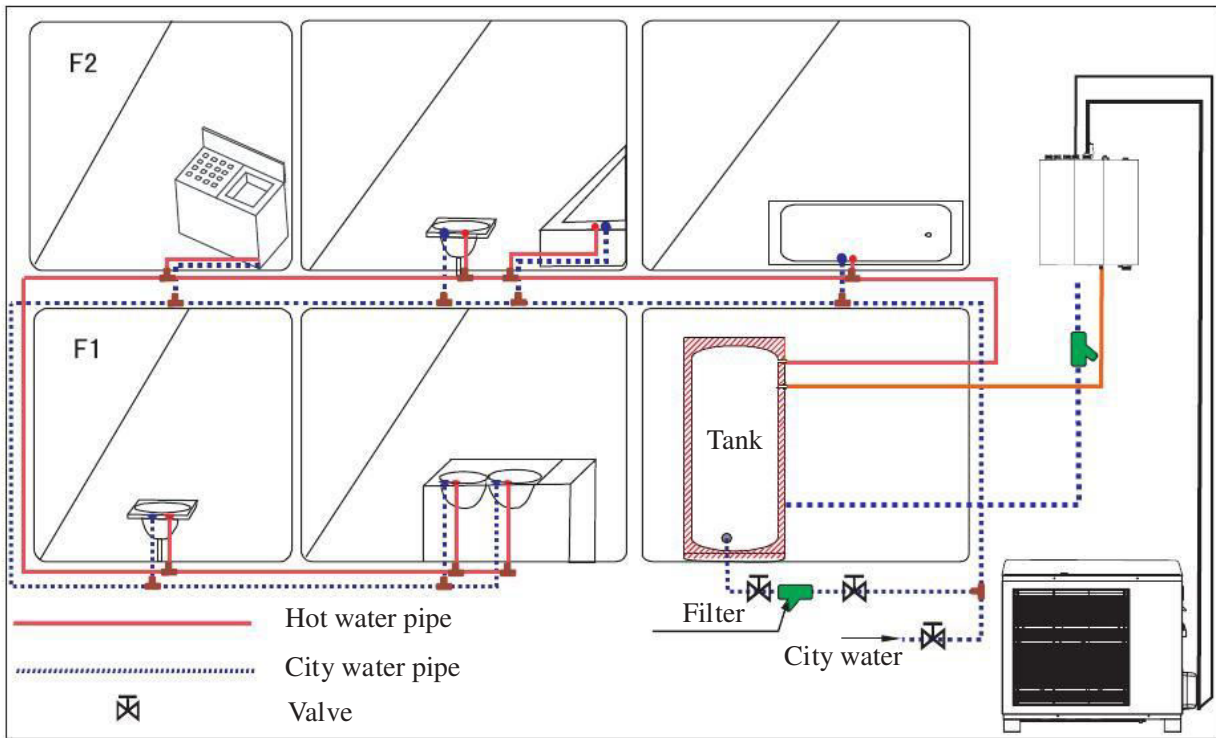

1. The installation, dismantlement and maintenance of the heat pump must be performed by qualified personnel.

2. The unit must be installed outdoors in an area with sufficient clearance to provide free air circulation through the coil. Please refer to the following figure to choose the right place for the unit.

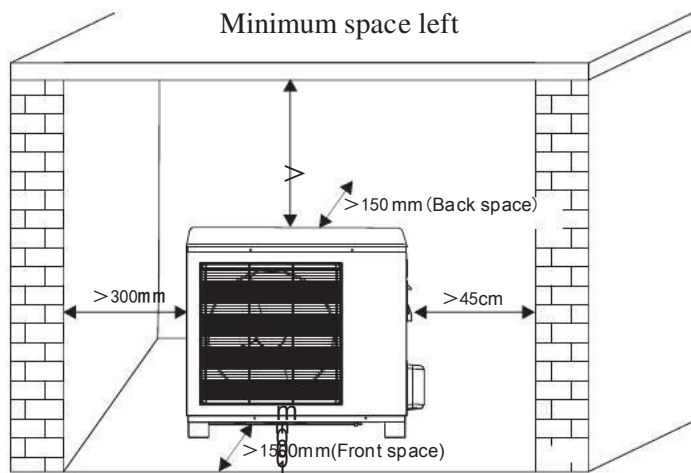

3. The outdoor unit should be placed at least 2M away from the ventilation outlet of kitchen, to keep the unit clean.

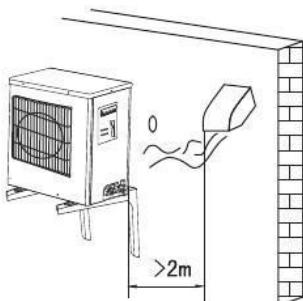

4. The indoor unit should be hung on the wall with the water connectors downwards.

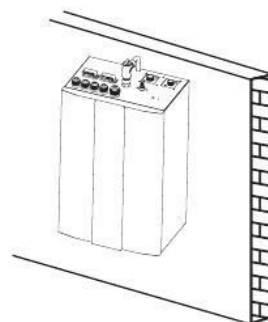

2. INSTALLATION

5. All the hot water pipe and water connections should be insulated, to reduce the energy loss.



6. A mesh filter must be installed in front of the water inlet of the unit and water tank, for keeping the water quality and collecting impurity contained in the water. Take care to keep the water filter mesh towards the bottom. Check valve is recommended to be installed at both sides of the filter, so as to clean or change the filter in a easier way.

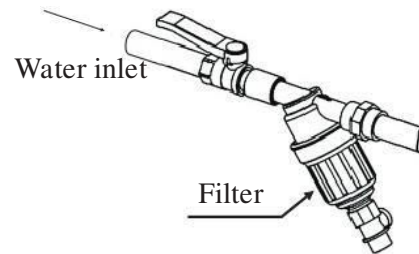

7. Shield the unit from direct sunshine, rain or snow, but never cover the unit which will cause the bad ventilation.

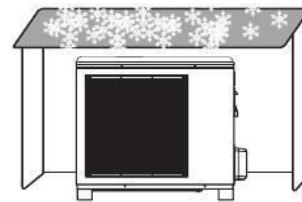

8. Install the unit and water tank close to each other as much as possible to reduce the distance between them, so to reduce the energy loss

9. The unit should be free from corrosive and moisture surrounding. Otherwise the lifetime of the unit might be shortened.

2.4 Installation of indoor unit

For the installation of the indoor unit, please refer to the followings:

1. Mark out the positions of the unit bracket on the wall. (refer fig.1)
2. Drill the holes on the wall. (refer fig.2)
3. Fix unit bracket with expansion bolts on the wall. (refer fig.3)
4. Then hand the indoor unit on the bracket. (refer fig.4)

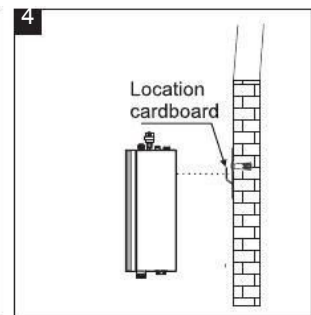
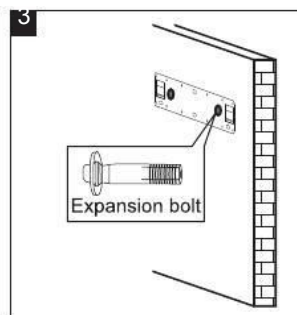
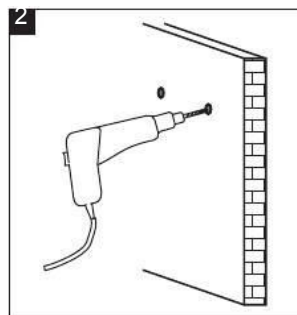
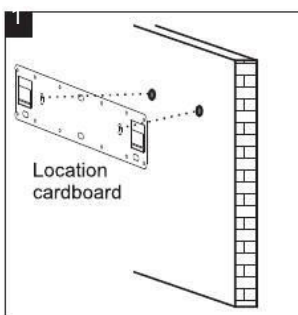

 Note: You must choose very firm wall for installation otherwise the bolts may get loose and cause unit damage!

2. INSTALLATION

2.5 Outdoor installation

A: If needs to hang the outdoor unit on the wall, please do as followings:

1. Adjust the location of the wall brackets according to the distance between two feet of the unit.
2. Fix the brackets on the wall with expansion bolts.
3. Place the outdoor unit on the brackets. A Vibration absorbers are recommended to reduce vibration and noise.
4. Fix the unit to the bracket.

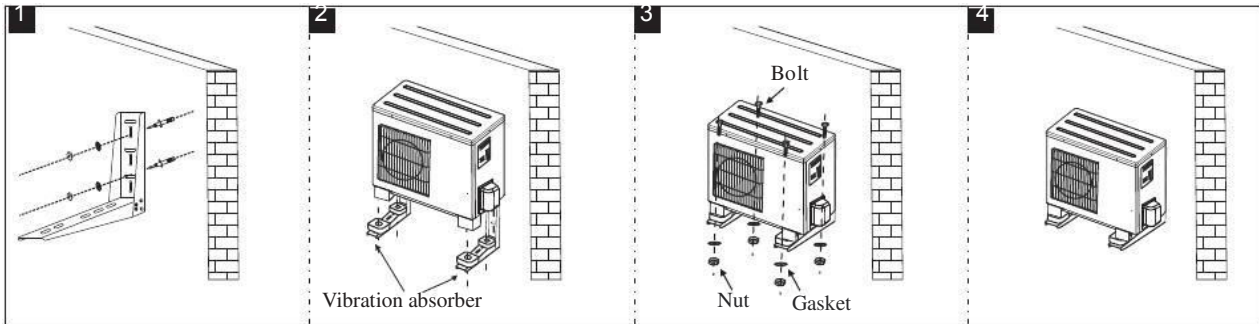

- ▲ It is recommended to use a wall sleeve to guide power cable and piping kits go through the wall.

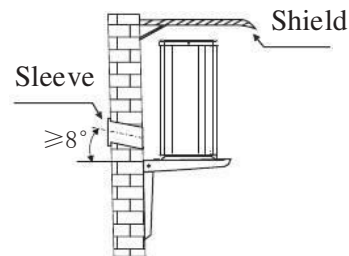

B: On a concrete stand

User can either use the dedicated mounting bracket from the supplier, or prepare a suitable bracket for the unit installation. Make sure the installation meets following requirements:

1. The unit must be installed on flat concrete blocks, or a dedicated mounting bracket. The bracket should be able to support at least 5 times of unit's weight.
2. All nuts must be tightened after the bracket is fixed; otherwise, it may cause damage to the equipment;
3. User should double check and make sure the installation of unit is firm enough.
4. The bracket can be of stainless steel, galvanized steel, aluminum and other materials as required by the user.
5. Besides the mounting bracket, the user can also install the outdoor unit on two concrete blocks, or a raised concrete platform. Please make sure that the unit is securely fastened after installation.
6. Please refer the dimension of outdoor unit when choose a suitable wall bracket.

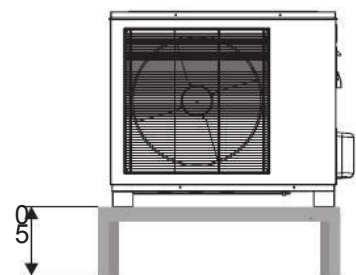

2. INSTALLATION

2.6 Wiring



1. It is recommended to use a suitable breaker for the heat pump and make sure the power supply to the heater corresponds to the specifications. Otherwise the unit might be damaged.
2. The power supply to the heat pump unit must be grounded.
3. Cable should be fixed tightly, to ensure it won't get loose.

A: Main power cable

1. Main power cable has connected into the terminal block of indoor unit. Please find the cable on top of indoor unit according to the label, and connect it to main power, as shown in the pictures below.

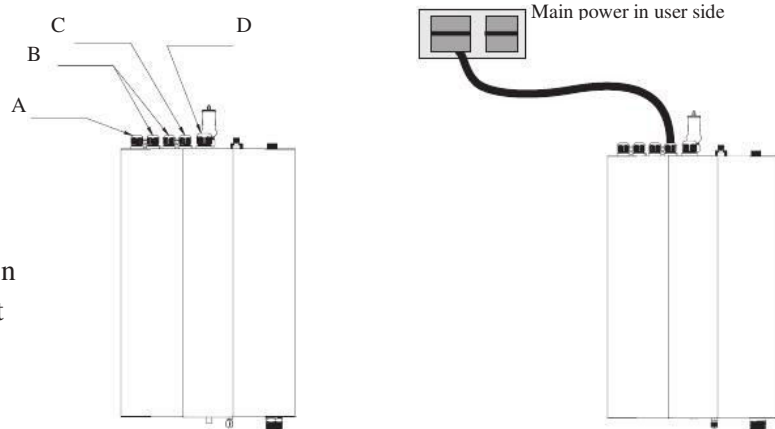

- A: Sensor cables
- B: Signal cables
- C: Main power cable
- D: Power cable between indoor and outdoor unit

B: Power cable between indoor and outdoor unit

1. The indoor front panel is fixed by four magnets in two sides of door. Please take off the front panel as fig. 1.
2. Remove one screw in left side of electric box, then open the door of electric box to right side as fig. 2.
3. Prepare a power cable of 3 core 2.5mm² and four cores with suitable length, insert the cable through cable gland on top of the indoor unit.

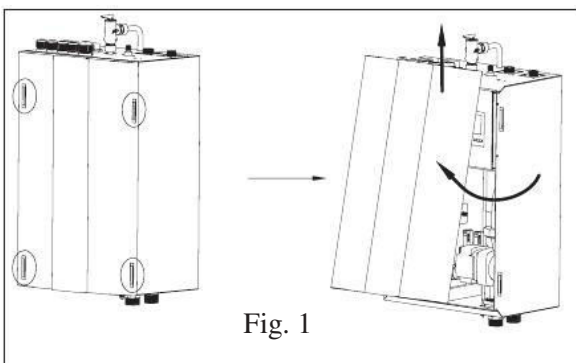

Fig. 1

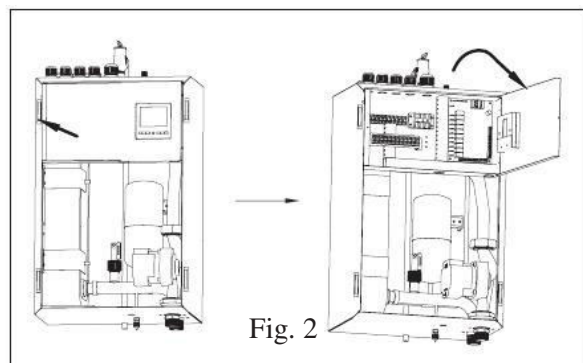

Fig. 2

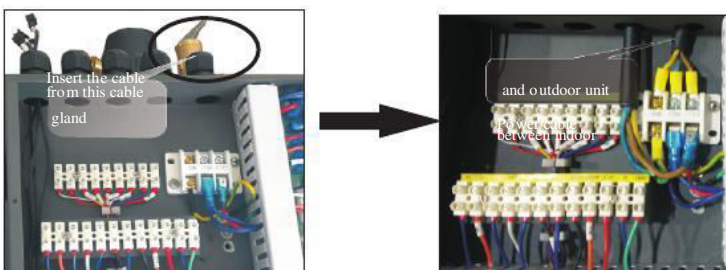
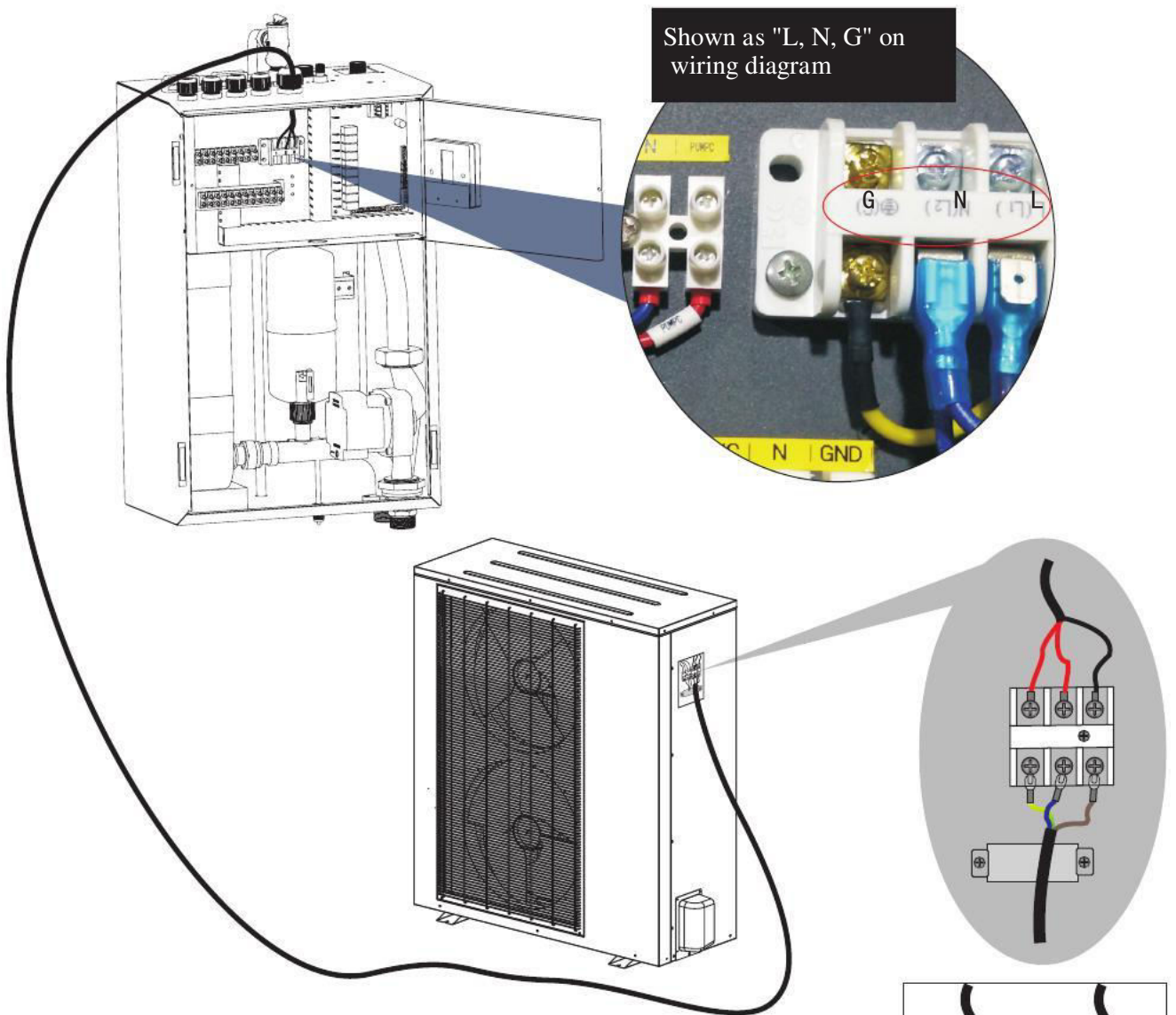

Fig. 3

2. INSTALLATION



Notice: When fixing the power cable with the wire clip, please be careful to clamp on the outer layer insulation, don't clamp on the wires inside, or it may cause damage on insulation layer of one-core wire.

4. Connect this power cable to "L,N and G" on indoor terminal block according to the wiring diagram of indoor unit.
5. Fasten the cable gland to ensure the cable won't get loosen.
6. Connect the other side of the power cable to the outdoor unit, according to the wiring diagram. Fix the cable with cable fixture, to ensure it won't get loose.

2. INSTALLATION

C. Signal cable between indoor and outdoor unit

Take the signal cable out from accessories bag.

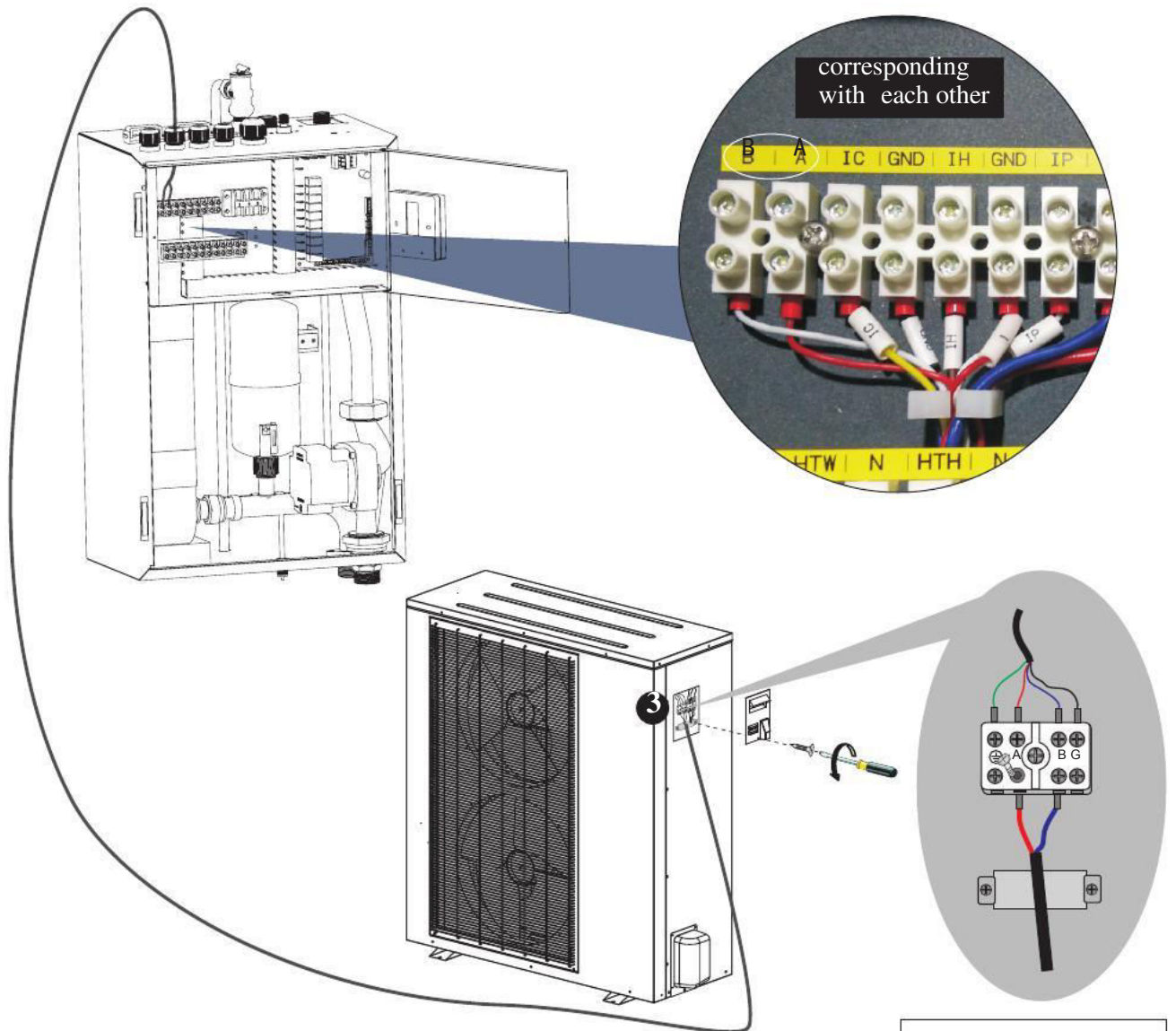

Notice: When fixing the power cable with the wire clip, please be careful to clamp on the outer layer insulation, don't clamp on the wires inside, or it may cause damage on insulation layer of one-core wire.

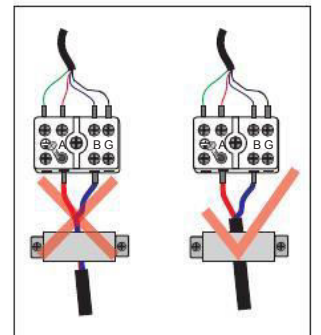

1. Insert one end of this cable through the cable gland on top of the indoor unit, and connect this cable to A, B on terminal block.
2. Fasten the cable gland to ensure the cable won't get loosen.
3. Connect the other end to the terminal block on outdoor unit. A, B on outdoor unit should be connected with A, B on indoor unit, otherwise unit will show communication failure.

2. INSTALLATION

When connecting the power cable between the outdoor unit and indoor unit, cables connected to the terminal block in indoor unit must match these in outdoor unit.

For example, if the terminals and power cables are connected as \ominus → green/yellow cable, L → red cable, N → blue cable, S → black cable in indoor unit, the connections in the outdoor unit should be in the same way.

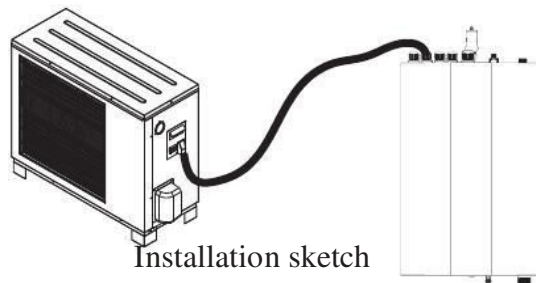

E. Sensor cables

The sensors are installed in the indoor unit. If you need to extend the sensors to wherever you need, please take all the extension cables for sensor out from the accessories bag.

1. Disconnect the sensor with the quick connector inside the indoor unit.
2. Insert the sensor cable from indoor PCB through cable gland on top of indoor unit.
3. Connect the sensor cable which stick out on top of indoor unit with extension cable for sensor.
4. Connect the other side of extension cable with the sensor.
5. Place the sensor in right position, according to your application, as shown in the pictures below.

Sensor cables

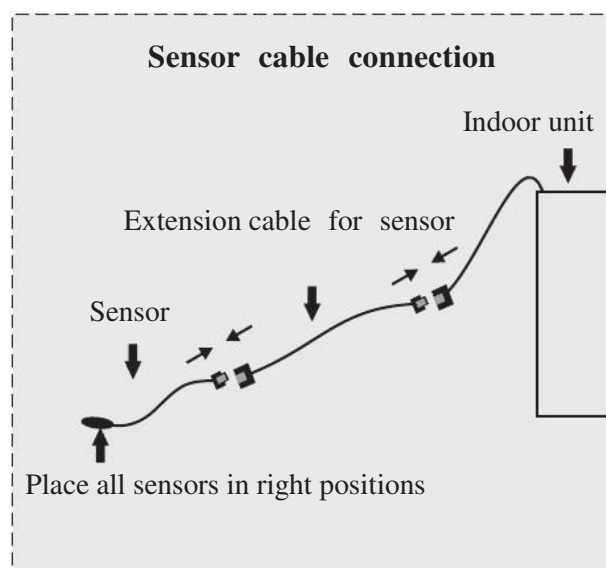
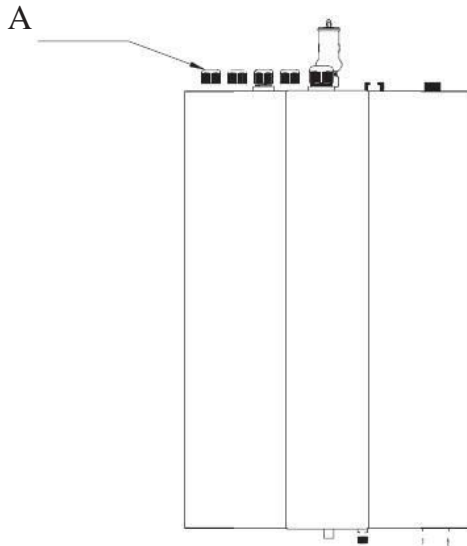

2. INSTALLATION

2.7 Connection of refrigerant pipe

A:For the unit with quick connector

Begin routing from the indoor unit and straighten out the pipes as you go. On the pipe ends in the installation kit are cap nuts for connection to the cannot be installed incorrectly. Hold the connection in place with one spanner and tighten the cap nut with the other, as otherwise the connection can be damaged.

Connect the installation kit's pipes to the connections on the indoor unit. First screw together

the screw connections by hand and then tighten using the spanners. Tighten the connection fully without stopping. A hissing noise can be heard. Hold the connection in place with one spanner and tighten the cap nut with the other. Tighten to at least 18Nm. Use a torque wrench if you are unsure. Never turn the fixed connections. Use the spanner only as a counter hold during connection. If a counter hold is not used, the connections can turn, which can destroy them. Tighten the connections 24 hours after installation has been completed.



IMPORTANT:

Note that the pipes in the installation kit are filled with gas and must not be cut under any circumstances.

The plastic plugs on the ends of the pipe must not be removed until the pipes are to be connected. If the pipes are bent and causing leakage, the couplings must be loosened so that the non-return valves close.

Route the pipes from the indoor unit and connect them in the same way to the outdoor unit.

Refrigerant pipes must not be bent to a radius of less than 15cm (check with a cardboard template). Route the electrical cable along the pipes. Bend the pipes carefully, a little at a time. Do not bend the pipes too sharply.

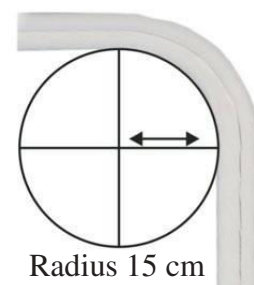

2. INSTALLATION

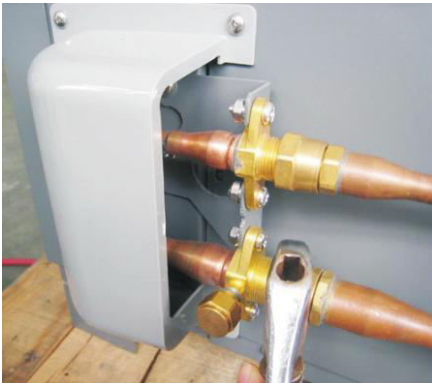

Connect the installation kit's pipes to the connections on the outdoor unit. First screw together the screw connections by hand and then tighten using the spanners.

Tighten the connection fully without stopping. A hissing noise can be heard. Hold the connection in place with one spanner and tighten the cap nut with the other.

Never turn the fixed connections. Use the spanner only as a counter hold is not used, the connections can turn, which can destroy them. Tighten the connections 24 hours after installation has been completed.

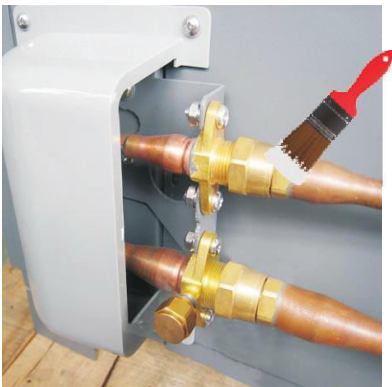

Check the seals and tighten the couplings again 12-24 hours after installation. Check for leaks by wetting with soapy water. Also check the connections at the indoor unit. If no bubbles appear, the couplings are properly connected and tightened!

B: For the unit with flare nut connection

Note: When vacuuming the system, please don't turn on the high/low pressure valve. Otherwise refrigerant leaks.



2. INSTALLATION

1. Connect the refrigerant piping to the indoor unit(refer fig.1).
2. Connect the other side of the refrigerant pipe to the the outdoor unit(refer fig.2).
3. Prepare a vacuum pump and a pressure gauge, connect one tube of the pressure gauge to the vacuum pump.(refer fig.3).



4. Connect the other tube of the pressure gauge to the outdoor unit.(refer fig.4).
5. Open pressure gauge, and start the vacuum pump to vacuum the unit for around 10 minutes.
When the pressure gauge shows negative pressure, close the pressure gauge and stop vacuuming (refer fig.5).

⚠ Attention:The liquid valve can't be opened until the vacuumizing has been totally finished.

6. Turn off the vacuum pump and install the copper nut back to the high pressure connector (refer fig.6).
7. Use a 5mm hex wrench to open two valves on the unit as shown in the picture(refer fig.7).
8. Check with leakage detector or soap water if there is any leakage. If not, then put back the copper nuts onto the valves(refer fig.8).

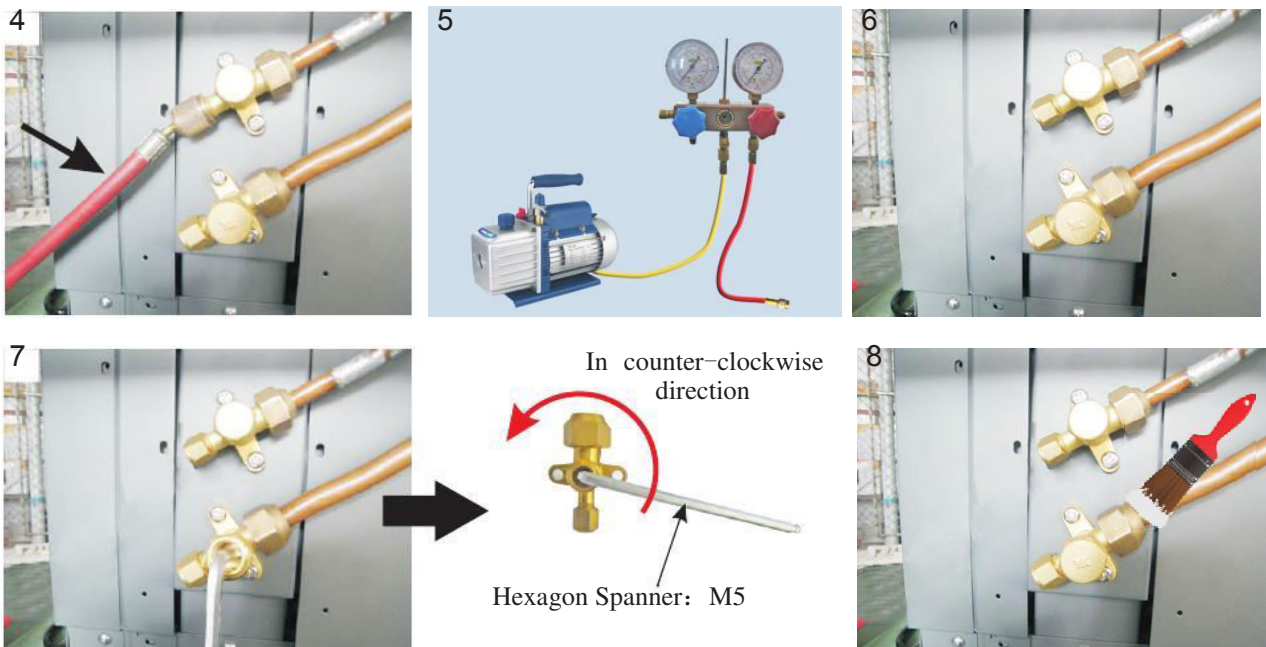

2. INSTALLATION

2.8 Installation of pressure release valve

1. Take out 2 sealing rings, a pressure release valve and a copper pipe from accessories, as fig. 1 and 2.
2. Connect pressure release valve with copper pipe, and put a sealing ring between them, to avoid leakage, as fig. 3 and 4.
3. Pass the copper pipe through the casing, and it stick out from the bottom of the unit.
4. Connect the other side of pressure release valve with the connector on top of indoor unit, and put a sealing ring between them, to avoid leakage. Fasten the pressure release valve by a wrench, as fig. 7 and 8.



Fig. 1



Fig. 2



Fig. 3



Fig. 4

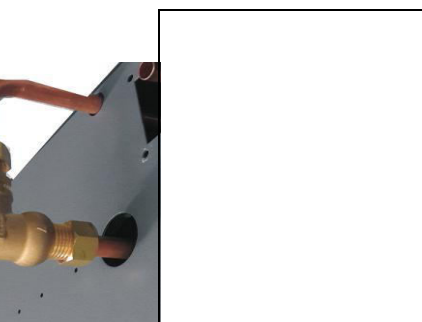

Fig. 5



Fig. 6



Fig. 7



Fig. 8

2. Installation

2.9 Water pipe connection

After installing the unit, please connect the water inlet and outlet pipe according to the local regulations. Please carefully select and operate the water pipe.

After connection, the water piping should be pressure tested, cleaned before use.

【Filter】

A mesh filter must be installed in front of the water inlet of the unit and water tank, for keeping the water quality and collecting impurity contained in the water. Take care to keep the water filter mesh towards the bottom. Check valve is recommended to be installed at both sides of the filter, so as to clean or change the filter in a easier way.

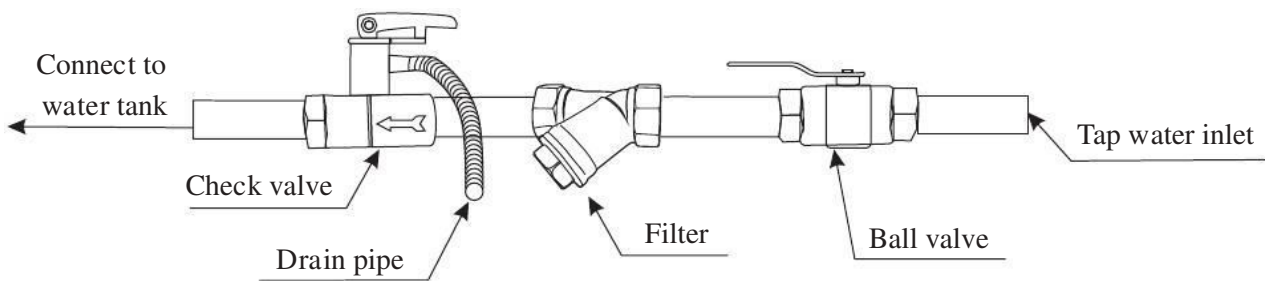

【Insulation】

All pipes running hot water should be well insulated. The insulation must be tied up tightly without gap (But please don't wrap up the check valve for future maintenance).



Please ensure enough water pressure to send the water to the required height.
If the water pressure is not enough that cause the system has too small water flow rate, please add water pump to increase the pumping head.

【Requirements of water quality】

1. Chloridion element in the water should be less than 300ppm(temperature is less than 60°C)
2. PH value of water should be from 6 to 8.
3. The water with ammonia can't be used for the unit.

If the water quality is bad, or water flow too little, scale formation or clogging may happen after unit running for a long time, then the efficiency of cooling or heating will be low or the unit will work abnormally.

Please clean water before use or use purified water. Make sure the water quality is good enough to keep the unit long-term running in high efficiency.

2. INSTALLATION

2.10 Air purging

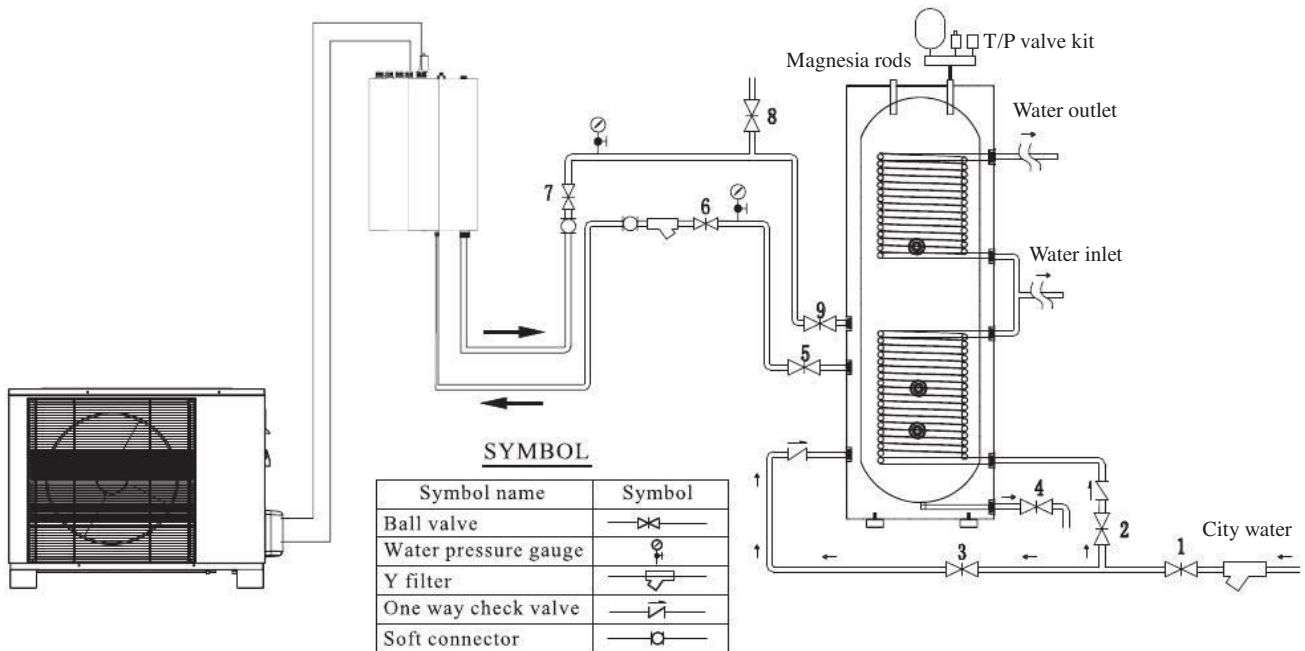

【Air purging of water system】

1. Open ball valve 3,5,6,7 and 8, close ball valve 2,4 and 9.
2. Open ball valve 1, making the tap water come into the water tank until water come out from ball valve 8 and T/P valve kit.
3. Close ball valve 8 and open ball valve 9, then air purging finishes.

【Air purging of hot water pipingsystem】

After finish the air purging of water system, open ball valve 2 until water come out from water outlet 1 and 2.

【Note:】

1. The above application illustration just shows hot water piping.
2. The above application illustration is just for reference. Different installation application has different operations for air purging. But the theory is the same. Check the water flow direction, open the valves to fill the water tank and all the pipings with water. Use the air purging valve in the system to discharge the air till water comes out from the air purging valves. Close the air purging valves, then the air purging finish.

2. INSTALLATION

2.11 Test run

【Pre Start-up】

Before starting up the unit, a certain number of verifications must be performed on the installation to ensure that the unit will operate under the best possible conditions. The check list below is not exhaustive and should only be used as a minimum reference basis:

1. Make sure fan rotates freely;
2. Inspect all water piping for flow direction;
3. Verify all system piping is correct for operation as per installation requirements;
4. Check voltage of the unit power supply and make certain voltage is within authorized limitations;
5. Make sure the unit is properly grounded;
6. Check the presence of protective and breaking devices;
7. Check all electric connections for tightness.
8. Check all piping for leaks and air is well ventilated.



If everything above is OK, the unit can start up.
If any of them fails, please fix it.

【Pre-start up】

- A. When the installation of unit is completed, water system pipes are well connected and air purging is done, no leakage or other problems, the unit can be powered to start up.
- B. Turn on the unit, press the on-off button on the operation panel to start the unit. Please check carefully if there is some abnormal noise or vibration, or the display of wired controller is normal or not.
- C. After the unit is working properly for 10 minutes, without any problem, then the pre-start up is completed; If not, please refer to the Service and Maintenance chapter in this manual to solve the problems.



It is suggested not to run "heating" or "hot water" mode, when ambient temperature is over 32 °C, otherwise unit may go into protection mode easily.





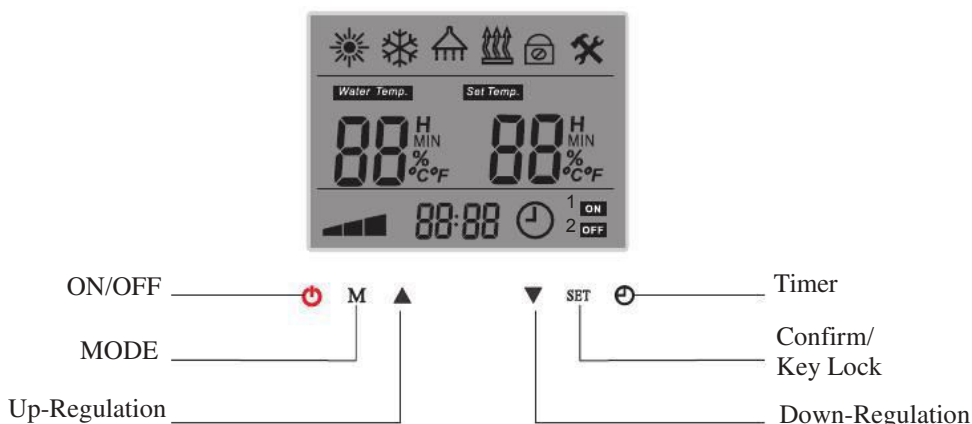

3. USEAGE

3.1 Introduction of operation panel



Symbol	Function	Explanation	Working mode
	Heating mode	When heating mode is selected, symbol is shown in the display	Symbol shown i display when selected, flickers when activated
	Cooling mode	When cooling mode is selected, symbol is shown in the display	Symbol shown i display when selected, flickers when activated
	Shower Water mode	When shower water mode is selected, symbol is shown in the display	Symbol shown i display when selected, flickers when activated
	Auxillary heater step 1 and step 2	When auxillary heater is connected and activated, symbol is shown in the display	Symbol flickers when step 1, 2 or both are "ON"
	Anti feezing protection	Self proteckting function to avoid freezing when ambient temperature drops and unit is in "OFF" mode. (Not adjustable)	When activated this symbol starts flickering
	Anti legionella function	Increases the shower water temperature wirth electric heater weekly to kill bacterias	Symbol starts flickering when function is "ON"
	Actual water temperature	Shows the actual water temparature in according to units operation mode	Always "ON" when unit is "Water Control" Always "OFF" when unit is "Room Control"
	Actual set temperature	Shows the actual set temparature in according to units operation mode	Always "ON" when unit is "ON"
	Heat recovery function	Not available for this model	
	Quiet operation	Lower the working speed of compressor and fan motors in selected time periode	When activated this symbol is "ON"
	Defrosting	Deicing the outdoor unit evaporator when ice is build up. (Self learning, not adjustable)	When defrosting is activated this sumbol is "ON". For dual compressor system: left symbol = system 1, right symol = system 2.
	Degrees in Celsius of Fahreneit	Shown when digits is correspondent with temperatures	
	Operation values	Shows selected temperature values when unit is on or parameter setting values	When parameter setting is selected, values are shown in accordance to the parameter setting menu

3. USEAGE

Symbol	Function	Explanation	Working mode
	Compressor indicator	Indicates the current working level, "low range30-46", "middle range47-65", "high range66-100"	If symbol is "ON" compressor is working
	Clock or parameter indicator	Clock and parameter menu and group indicator	Shows time when unit is "ON", Shows parameter groupe or -number when unit is "OFF" and parameter setting is selcted
	Timer	Indicates that one or more operation timer parameters is selected	When "ON" means unit is "OFF" until the selected time where unit is set to be "ON"
1	Timer Shower water	Indicates that shower water is set to "Timer" operation, and weather it is in "ON" periode and if unit actually is working in this mode.	"1" shows that "Timer" for shower water mode is selcted and that unit is within its "ON" periode. "ON" indicates that unit is actually working in shower water mode
2	Timer heating/cooling	Indicates that heating/cooling mode is set to "Timer" operation, and weather it is in "ON" periode and if unit actually is working in this mode.	"2" shows that "Timer" for heating/cooling mode is selcted and that unit is within its "ON" periode. "OFF" indicates that unit is not working in heating/cooling mode at the moment
	ON/OFF	Button switch the entire unit on and off	Button also have some parameter setting functions
M	selector	Button switch between basic operation modes, Heating/cooling/shower/water, and different combinations of these	Button also have some parameter setting functions
	UP value	Button increases set temperature, switch between parameters or adjust set value in parameter setting menu	Button also have some parameter setting functions
	Down value	Button deacreases set temperature, switch between parameters or adjust set value in parameter setting menu	Button also have some parameter setting functions
SET	Set button	Button activates the unit for changing in set values in temperatures or parameters	Button also have some parameter setting functions
	Clock/Timer button	Button enters clock and timer settings	Button also have some parameter setting functions

Operation mode

3. USEAGE

3.2 Parameter Setting Overview

Item	Sub-menu	Unit Statue Under	Operation Level	Page in the menu	Default factory settings
Clock Time	None	OFF	User	53	00:00
Temp. Setting	Hot water/Heating/Cooling	ON	User	54	
Working Mode	Hot water, heating, cooling, hot water+heating, hot water+cooling, heating+cooling, hot water+heating+cooling	ON	User	53	
Room Temp. Control		ON	User	54	20°

No matter the unit is ON or OFF, press \odot button to check or activate "Timer" parameter setting. Use \blacktriangle or \blacktriangledown button to view all parameters in sequence. When the value of a parameter needs to be adjusted, press "SET" when this parameter is shown to activate the setting of this parameter. The value start flickering. Use \blacktriangledown button to adjust the value, or \blacktriangle button to adjust setting in "hours", \blacktriangledown button to adjust the setting in "minutes", if this parameter is a time parameter.

Item	Sub-menu	Unit Statue	Operation Level	Page in the menu	Default factory settings
Timer Parameter	Timer function ON/OFF	ON/OFF	User	55~56	0 (OFF)
	Hot Water Timer ON-1			56	00:00
	Hot Water Timer OFF-1				00:00
	Hot Water Timer ON-2				00:00
	Hot Water Timer OFF-2				00:00
	Heating/Cooling Timer ON-1				57
	Heating/Cooling Timer OFF-1			00:00	
	Heating/Cooling Timer ON-2			00:00	
	Heating/Cooling Timer OFF-2			00:00	
	Normal Shower Time (for unit with heat recovery function only)			57~58	00:00
	Anti-legionella function			58	00:00
	Anti-legionella function starting time				00:00
	Pump anti-block running time				00:00
	Quiet operation starting time				00:00
Quiet operation ending time	00:00				

3. USEAGE

All the units sensor values (temperatures) and information of current running statue (compressor speed, voltage and current) can be red and checked via operation panel in both ON/OFF statue. Press ▲ and ▼ buttons for 5 seconds in main interface, to activate the menu of current running statue. Press ▲ or ▼ buttons to check all working status in sequence in accordance to below list. The current number is displayed where the clock is displayed in main interface. See operation panel symbols in page...

Item	Meaning	Item	Meaning
1	Ambient temperature	16	System 1 evaporating pressure
2	Hot water temperature	17	System 1 condensing pressure
3	Cooling water temperature	18	System 2 voltage
4	Unit outlet water temperature	19	System 2 current
5	Unit inlet water temperature	20	System 2 compressor speed (in Hz)
6	System 1 indoor coil temperature	21	System 2 outdoor coil temperature
7	Heating water temperature	22	System 2 compressor discharge
8	System 2 indoor coil temperature	23	System 2 suction temperature
9	Room temperature	24	System 2 evaporating pressure
10	System 1 voltage	25	System 2 condensing pressure
11	System 1 current	26	System 1 EEV position
12	System 1 compressor speed (in Hz)	27	System 2 EEV position
13	System 1 outdoor coil temperature	28	Failure bit
14	System 1 compressor discharge	29	Protection bit
15	System 1 suction temperature	30	N/A

Temperature Parameter under basic operation level can be set in "OFF" mode only. Press "SET"+"M" for 5 seconds, Parameter will shown on the display. Press ▲ or ▼ to check parameter values for each paramter in sequence.

Item		Unit Statue	Operation	Page in the menu	Default factory
Temperature Parameter		Check in in OFF		61	5°
	Heating restarts based on water ΔT			61	0 (OFF)
	Cooling and heating switch judgment				

3. USEAGE

Item	Sub-menu	Unit Statue	Operation Level	Page in the menu	Default factory settings
Temperature Parameter	Ambient temp. to startheating	Check in ON/OFF, Set in OFF	User	61	20°
	Ambient temp. to startcooling				25°
	Shiftingpriority			62	-5°
	Setroomtemperature				20°

1. Code input: When unit is in "OFF" mode, press ▼ for 5 seconds, "----" will be shown. Press ▲ to swfit between 4 positions, and press ▼ to adjust the value of the blinking value. Press "SET" to confirm the input password. If the password is correct, "Advanced Setting" mode is activated.

2. Complete Advanced Setting menu is divided into 6 groups (Group 0~Group E). When Advanced Setting menu is activated, press ⊙ to switch between each group(Group 0, A, B, C, D,E) .

3. Press ▲ or ▼ to switch different parameters in the same group. Press "SET" to activate setting of current parameter, with its value blinks, and adjust its value by ▲ or ▼. Press "SET" to confirm the setting.

	Sub-menu	Unit Statue	Level	the menu	Default factory settings
Advanced Setting Group	Test working mode indoor controller	OFF	Installer	66~67	0 (Normal
	External ON/OFF switch				0 (Invalid)
	Water flow switch			67	60 sec
	Cooling buffer tank				68
	Priority switch between hot water and heating operation			0 (hot water)	
	Refrigerant collecting function			0 (OFF)	
	Lock Function			00 (OFF)	
	Advanced Setting Group A			Unit Circulation Pump Control Type	
Heating Circulation Pump Control Type		0 (unit controlled)			
Cooling Circulation Pump Control Type		0 (unit controlled)			
Heating Circulation Pump Start Temperature		°			
Heating Cirulation Pump Stop Temperature		18°			
Cooling Circulation Pump Start Temperature		°			
Cooling Cirulation Pump Stop Temperature		°			

3. USEAGE

Item	Sub-menu	Unit Statue	Operation Level	Page in the menu	Default factory settings
Advanced Setting Group A	Unit Motorized 3-way valve Switching Time	OFF	Installer	70	120 sec
	Heating Operation Motorized 3-way valve Direction				operation
Advanced Setting Group B	Anti-Legionella Set Temperature	OFF	Installer	70	60
	Anti-Legionella Duration				30 min.
	Anti-Legionella Maximum Allowable Working Duration				120 min.
	Anti-freezing Function			71	1 (ON)
	Anti-freezing Starting Ambient Temperature--Primary				5°
	Anti-freezing Starting Ambient Temperature--Secondary				2°
	Anti-freezing Ending Ambient Temperature--Secondary				5°
	Anti-freezing Starting Water Temperature--Secondary				2°
	Anti-freezing Ending Water Temperature--Secondary				15°
Advanced Setting Group C	Manual ON/OFF of Heater in Hot Water Mode	OFF	Installer	72	0 (OFF)
	Backup Heating Source For Hot Water Mode				0 (No)
	Priority Of Backup Heating Sources For Hot Water Mode (Compared With Unit Auxiliary Heater)				0 (lower)
	Temperature Increasement Checking Duration in Hot Water Mode				40
	Maximum Allowable Set Water Temperature in Heating Mode				42
	Manual ON/OFF of Heater in Heating Mode			0 (OFF)	
	Backup Heating Source For Heating Mode			73	1 (Yes)
	Priority Of Backup Heating Sources For Heating Mode (Compared With Unit Auxiliary Heater)				1 (Higher)
	Accumulated Value between operation time VS set temp. for Heating Mode				45
Advanced Setting Group D	Heating Curve Function	OFF	Installer	63	1 (ON)
	Room Temp. Effect On Heating Curve			63	0 (OFF)

3. USEAGE

Item	Sub-menu	Unit Statue Under	Operation Level	Page in the menu	Default factory settings
Advanced Setting Group D	AmbientTemp. 1	OFF	Installer	63~64	12
	Ambienttemp 1 Vs WaterTemp. 1				25
	AmbientTemp. 2				7
	Ambienttemp2 Vs WaterTemp. 2				28
	AmbientTemp. 3				2
	Ambienttemp3 Vs WaterTemp. 3				31
	AmbientTemp. 4				-7
	Ambienttemp4 Vs WaterTemp. 4				35
	AmbientTemp. 5				-20
	Ambienttemp5 Vs WaterTemp. 5				42
Advanced Setting Group E	HeatRecoveryFunction	OFF	Installer	73~74	0 (Invalid)
	Hot Water Restart Based On ΔT in Heat Recovery Operation				5°
	Hot Water Stop Based On ΔT in Heat Recovery Operation				5°
	Allowable Temp Drift In Heating in Shifting Priority Operation			74	5
	Heating Max. Working Hours in Shifting Priority Operation				30
	Hot Water Min. Working Hours in Shifting Priority Operation				50
	Working of Extra Heating Source for Hot Water in Shifting Priority Operation				0 (No)

3. USEAGE

3.3 Basic Operation



【ON/OFF】

When the unit is OFF, press  to turn on the unit. The unit will work in its last working mode.

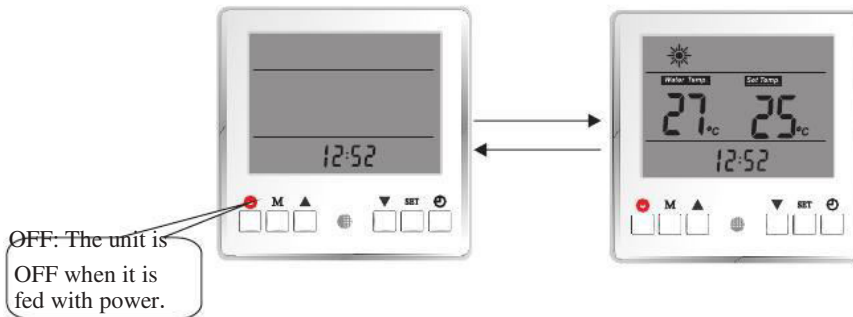
Press  again to turn off the unit.



【Clock time setting】

When the unit is in OFF mode, press "SET" for 5 seconds, to activate clock time setting, with the value flickers. Press  to adjust time by hours; press  to adjust time by minutes.

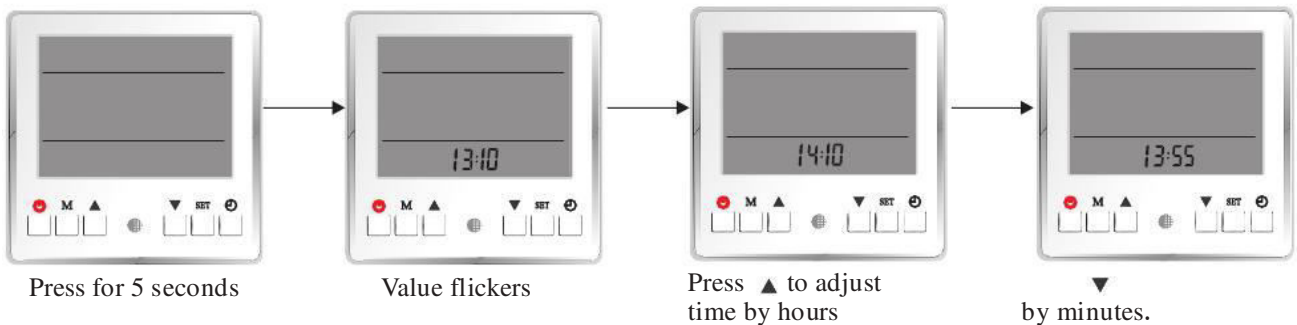





Press  to adjust time

【Working modes setting】

Chose working mode settings in accordance to your heating/hot water/cooling system.

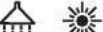
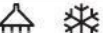
When the unit is ON, press "M" to set the unit working mode. For each time "M" is pressed working mode is changed by the below sequence. When a working mode is selected, its symbol(s) will be shown on the screen. The current working mode of the unit, is shown by a flickering working mode symbol.

Working Modes	Symbols
Hot water	
Heating only	
Cooling only	
Hot water+Heating	
Hot water+Cooling	
Auto	
Hot water+Auto	



Picture shows that heating and hot water mode is selected

3. USEAGE

【Room Temperature Control】

When unit is ON, keep on pressing "M" to switch the control of cooling and heating operation between room temperature control and water temperature control mode.

When in water temperature control mode, "Water Temp." will be shown on the screen ;

When in room temperature control mode, "Water Temp." will not be shown on the screen.

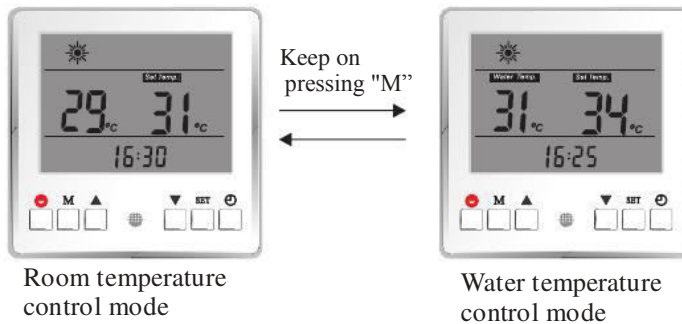

Note:

If unit is set to Hot Water mode only, or unit is set to combined working mode but unit is working in hot water mode, this operation is invalid.

【Temperature setting】

Single working mode

When unit is on and working mode is selected, press “set” to activate the temperature setting. Working mode symbol flickers.

Adjust the set temperature by:

Press ▲ to increase the set temperature by 1°C.

Press ▼ to decrease the set temperature by 1°C.

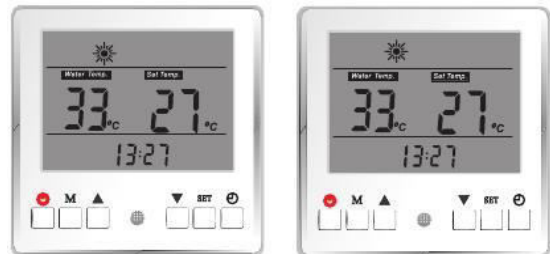

Combined working mode

When combined working mode is selected, unit will switch between selected working modes. For example heating + hot water, unit will switch between space heating and hot water operation. Press “set” to activate the temperature settings. The working mode symbol that is being adjusted, flickers. Adjust the temperature setting by using the ▲/▼ arrows.

Press “set” to confirm the setting, and activate following working modes temperature setting, with its working mode symbol flickers. Adjust the temperature setting by using the ▲/▼ arrows.

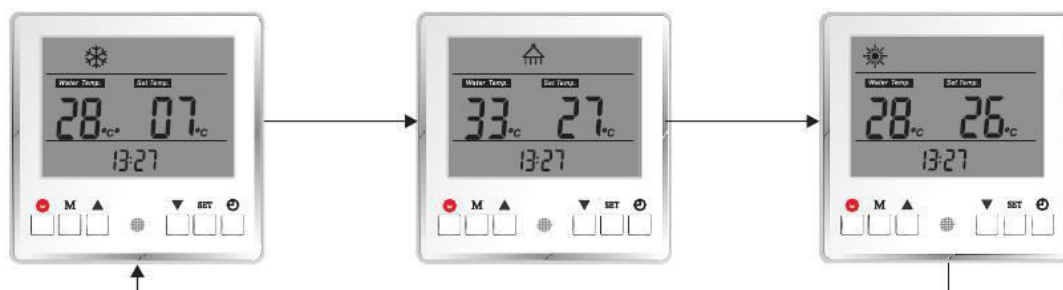

Press "SET" to switch the temperature setting between selected working modes in sequence.

- Note:**
1. If heating curve function is activated, set temperature for heating will be calculated according to the set curve automatically. Its set temperature can't be adjusted by this operation.
 2. If room temperature control mode is activated, temperature set here for heating and cooling is based on room temperature.

3. USEAGE

【Time&Timer Setting】



Timer function allows you to control different working modes at spesific hours during a 24 hour periode, for even more energy savings. For example you can turn off hot water production in the daily hours you don' t use this. In the selected periode unit will not produce hot water even hot water is selcted as working mode in your application. The setting is repeted every 24 hours until it is deactivated.

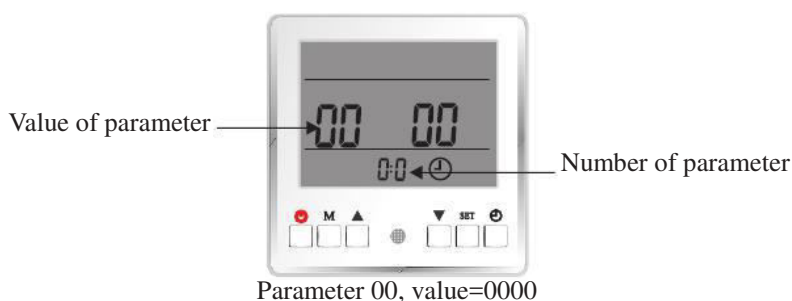

Parameter list

Parameter No.	Meaning	Range	Default Value
0	Timer function ON/OFF	0(off), 1(on)	0
1	Hot Water Timer ON-1	00 00-23 59	00 00
2	Hot Water Timer OFF-1	00 00-23 59	00 00
3	Hot Water Timer ON-2	00 00-23 59	00 00
4	Hot Water Timer OFF-2	00 00-23 59	00 00
5	Heating/Cooling Timer ON-1	00 00-23 59	00 00
6	Heating/Cooling Timer OFF-1	00 00-23 59	00 00
7	Heating/Cooling Timer ON-2	00 00-23 59	00 00
8	Heating/Cooling Timer OFF-2	00 00-23 59	00 00
9	Normal Shower Time (for unit with heat recovery function only)	00 00-23 59	00 00
10	Anti-legionella function	0(off), 1(on)	0
11	Anti-legionella function starting time	00 00-23 59	00 00
12	Pump anti-block running time	00 00-23 59	00 00
13	Quiet operation starting time	00 00-23 59	00 00
14	Quiet operation ending time	00 00-23 59	00 00

No matter the unit is ON or OFF, press  to check or actiave "Timer" parameter setting, which looks as shown below:



Use  or  to view all parameters in sequence. When the value of a parameter needs to be adjusted, press "SET" when this parameter is shown to activate the setting of this parameter. The value start flickering.

Use  to adjust setting in hours,  to adjust the setting in minutes" if this parameter is a time parameter

3. USEAGE

For example, parameter 00 is to set the ON/OFF of complete timer function (if it is set to OFF, following parameters 01~08 will be invalid). When setting for this parameter is activated, use ▼ to adjust the value.

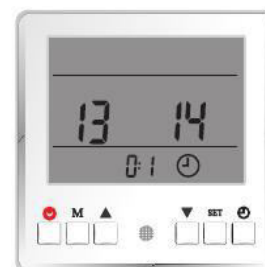

For example, parameter 01 is the ON time for hot water function. When setting for this parameter is activated, press ▲ to adjust the setting in hours; press ▼ to adjust the setting in minutes for parameter that relates to time

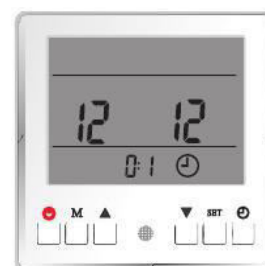

Meaning of each parameter

Timer setting parameter 0 to 8.

To be able to activate timer setting for parameter 1 to 7, parameter 0 needs to be activated first.

Parameter No.	Meaning	Range	Default Value
0	Timer function ON/OFF	0(off), 1(on)	0

Hot Water Timer:

Parameter No.	Meaning	Range	Default Value
1	Hot Water Timer ON-1	00 00-23 59	00 00
2	Hot Water Timer OFF-1	00 00-23 59	00 00
3	Hot Water Timer ON-2	00 00-23 59	00 00
4	Hot Water Timer OFF-2	00 00-23 59	00 00

These parameters are used for setting the ON/OFF timer for hot water operation. After setting, unit will only activate hot water operation in the selected period(s).

For example, if the below setting is set; domestic hot water will only be heated up during the period 04:00~09:00, and 14:00~21:00 every day.

Parameter No.	Meaning	Value
1	Hot Water Timer ON-1	04 00
2	Hot Water Timer OFF-1	09 00
3	Hot Water Timer ON-2	14 00
4	Hot Water Timer OFF-2	21 00

For how to make the setting, please refer to previous page.

3. USEAGE

Heating/Cooling Timer:

Parameter No.	Meaning	Range	Default Value
5	Heating/Cooling Timer ON-1	00 00-23 59	00 00
6	Heating/Cooling Timer OFF-1	00 00-23 59	00 00
7	Heating/Cooling Timer ON-2	00 00-23 59	00 00
8	Heating/Cooling Timer OFF-2	00 00-23 59	00 00

These parameters are used for setting the ON/OFF timer for heating or cooling operation. After setting, unit will only activate heating or cooling operation, when needed, in the set timer period. For example, below setting is made

Parameter No.	Meaning	Value
5	Heating/Cooling Timer ON-1	00 00
6	Heating/Cooling Timer OFF-1	08 00
7	Heating/Cooling Timer ON-2	17 00
8	Heating/Cooling Timer OFF-2	23 59

Then heat pump will only heat or cool the house during the period 00:00~08:00, and 17:00~23:59 every day.

When timer function is activated, following symbols might be shown on the screen:



This symbol means the unit is in sanitary hot water Timer ON period. Unit will work in hot water mode when needed.

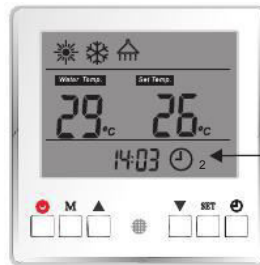

This symbol means the unit is in cooling/heating Timer ON period. Unit will work in cooling/heating mode when needed.



This symbol means the unit is in sanitary hot water and cooling/heating Timer ON period. Unit will work for both hot water and cooling/heating mode (not in same time) when needed.

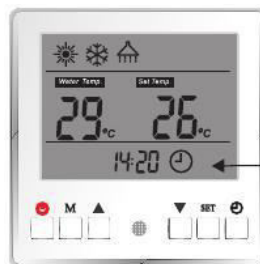

This symbol means the unit is neither in hot water nor cooling/heating Timer ON period. Unit will work not work for both hot water and cooling/heating mode even needed.

Normal Shower Time:

Parameter No.	Meaning	Range	Default Value
9	Normal Shower Time (for unit with heat recovery function only)	00 00-23 59	00 00

This parameter is designed for the unit with heat recovery function only. When using recovered heat to heat up sanitary hot water, it is not always enough to heat up the shower water. If 1 hour before this "Normal Shower Time" set time is reached, hot water temperature has still not reached the set value, unit will activate standard hot water operation to ensure you can enjoy enough hot shower water at/after this time.

3. USEAGE

For example, if the setting is made like below:

Parameter No.	Meaning	Value
9	Normal Shower Time (for unit with heat recovery function only)	20 00

If at time 19:00 in the day, shower water is still not enough for shower, unit will activate standard hot water operation, instead of using recovered heat to heat up the shower water.

Anti-legionella function

Parameter No.	Meaning	Range	Default Value
10	Anti-legionella function	0(off), 1(on)	0
11	Anti-legionella function starting time	00 00-23 59	00 00

Parameter 10 is used to activated or deactivate Anti-legionella function.

Parameter 11 is used to set the starting time of Anti-legionella function.

During the hot water operation, unit will record the highest hot water temperature it produced. If in 7*24 hours time period, unit has not reached the set water temperature for "anti-legionella function" (set in Advanced Menu) even once, then unit will activate anti-legionella operation at "Anti-legionella function starting time".

For details for "anti-legionella" function, please contact your installer or read chapter "Advanced Opeartion" in our manual.

Pump anti-block running time

Parameter No.	Meaning	Range	Default Value
12	Pump anti-block running time	00 00-23 59	00 00

Circulation water pump may easily get blocked if it has not working for long time. In order to avoide this from happening, circulation water pump will be activated for 1 minute, if it is not working at this set clock time every day.

Quiet operation

Parameter No.	Meaning	Range	Default Value
13	Quiet operation starting time	00 00-23 59	00 00
14	Quiet operation ending time	00 00-23 59	00 00

Thanks for the DC technology applied in this system, unit can lower both its compressor speed and fan rotating speed, to get a ultra low noise operation in this set time period.

【Temperature Info】

All temperature information of current running statue can be checked via operation panel in both ON/OFF status.

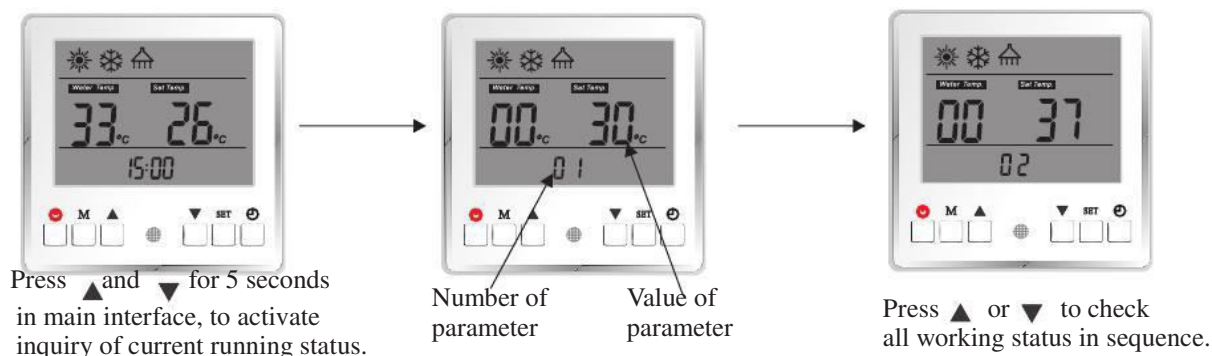

3. USEAGE

Meaning of all readings:

Item	Meaning	Item	Meaning
1	Ambient temperature	16	System 1 evaporating pressure
2	Hot water temperature	17	System 1 condensing pressure
3	Cooling water temperature	18	System 2 voltage
4	Unit outlet water temperature	19	System 2 current
5	Unit inlet water temperature	20	System 2 compressor speed (in Hz)
6	System 1 indoor coil temperature	21	System 2 outdoor coil temperature
7	Heating water temperature	22	System 2 compressor discharge
8	System 2 indoor coil temperature	23	System 2 suction temperature
9	Room temperature	24	System 2 evaporating pressure
10	System 1 voltage	25	System 2 condensing pressure
11	System 1 current	26	System 1 EEV position
12	System 1 compressor speed (in Hz)	27	System 2 EEV position
13	System 1 outdoor coil temperature	28	Failure bit
14	System 1 compressor discharge	29	Protection bit
15	System 1 suction temperature	30	N/A

【Temperature Parameter】

Temperature Parameter under basic operation level can be checked in both ON and OFF mode.

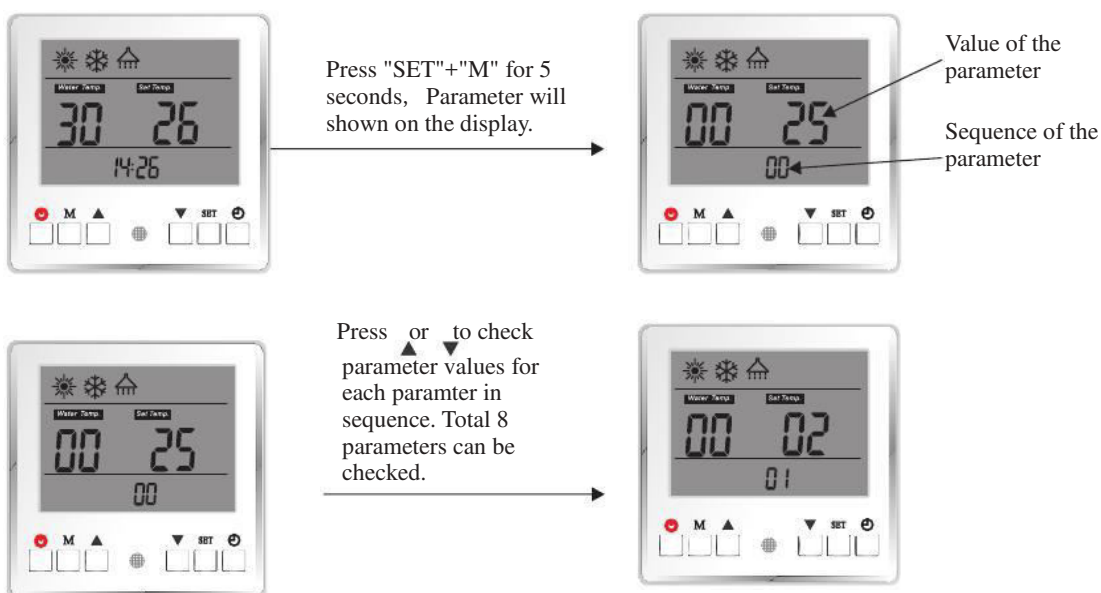

3. USEAGE

Temperature Parameter under basic operation level can be set in "OFF" mode only.

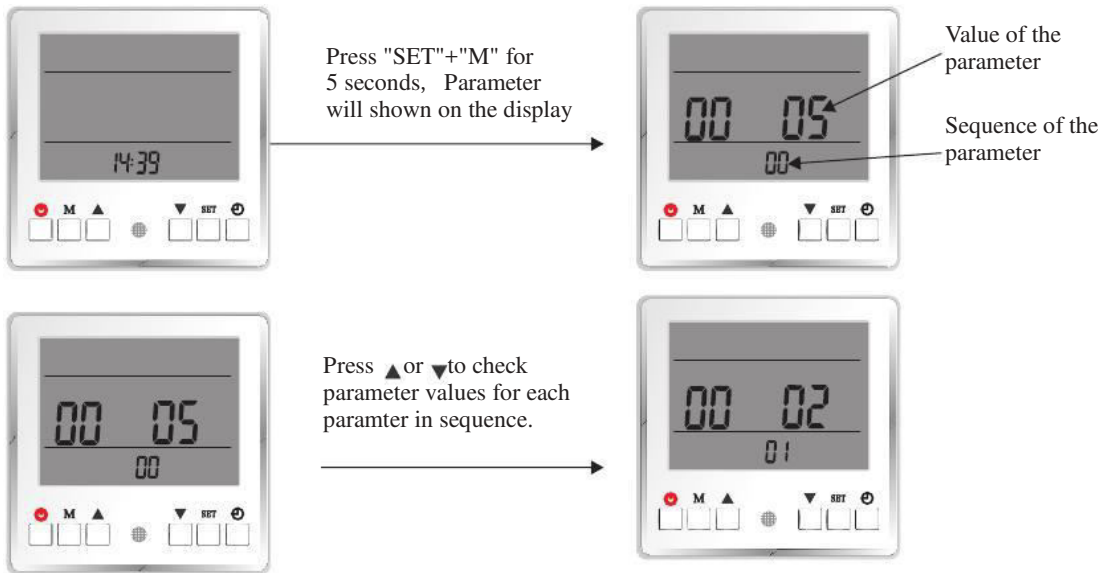

Press "SET" to activate setting of current parameter, with its value blinks.

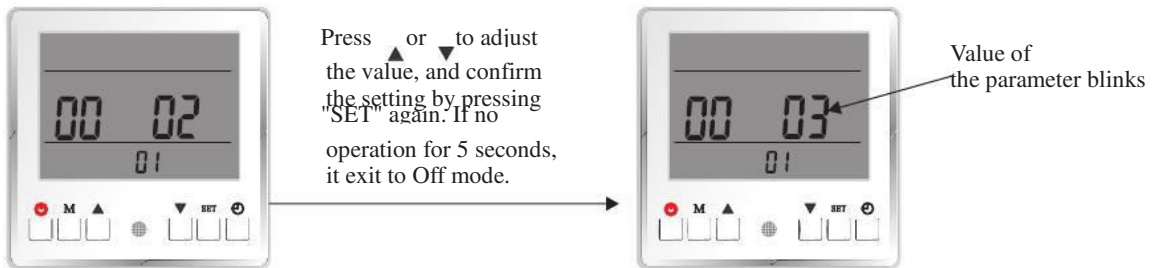

In OFF mode, default paramter settings of factory can be recovered by pressing "M"+"▲".

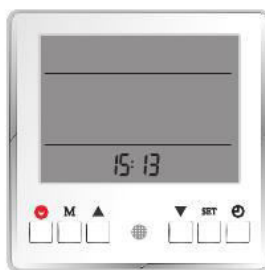

3. USEAGE

List of parameters

Parameter No.	Meaning	Range	Default Value
0	Domestic Hot Water Restart Based On Water ΔT	0 - 10 (in $^{\circ}C$)	5
1	Heating Restarts Based On Water ΔT	0 - 10 (in $^{\circ}C$)	2
2	Cooling Restarts Based On ΔT	0 - 10 (in $^{\circ}C$)	2
3	Cooling and Heating Switch Judgment	0(via. Ambient Temp.), 1 (via. External Signal)	0
4	Ambient Temp. To Start Heating	-10 - 20 (in $^{\circ}C$)	20
5	Ambient Temp. To Start Cooling	21 - 35 (in $^{\circ}C$)	25
6	Shifting Priority	-20 - 20, 100 (stands for invalid)	-5
7	Set Room Temperature	10-31 (in $^{\circ}C$)	20

Meaning of each parameter

List of adjustable parameters in Temperature Parameter Setting menu:

Parameter No.	Meaning	Range	Default Value
0	Domestic Hot Water Restart Based On Water ΔT	0 - 10 (in $^{\circ}C$)	5
1	Heating Restarts Based On Water ΔT	0 - 10 (in $^{\circ}C$)	2
2	Cooling Restarts Based On ΔT	0 - 10 (in $^{\circ}C$)	2

Domestic Hot Water Restart Based On ΔT :

After sanitary hot water is heated up to the set temperature, unit will stop sanitary hot water operation. It will activate sanitary hot water operation after temperature drops "Hot Water Restart Based On Water ΔT " below set temperature.

Heating Restart Based On ΔT :

After house heating temperature is heated up to the set temperature, unit will stop heating operation. It will activate heating operation after temperature drops "Hot Water Restart Based On ΔT " below set temperature.

Cool Restart Based On ΔT :

After house cooling temperature is cooled down to the set temperature, unit will stop cooling operation. It will activate cooling operation after temperature increases "Hot Water Restart Based On ΔT " above set temperature.

Parameter No.	Meaning	Range	Default Value
3	Cooling and Heating Switch Judgment	0(via. Ambient Temp.), 1 (via. External Signal)	0
4	Ambient Temp. To Start Heating	-10 - 20 (in $^{\circ}C$)	20
5	Ambient Temp. To Start Cooling	21 - 35 (in $^{\circ}C$)	25

If "Auto" mode (unit operation mode, set by press "M" button) is set, unit needs to switch between cooling and heating automatically, either according to "ambient temperature" (parameter 3=0) or "external signal" (parameter 3=1).

If setting= "via. Ambient Temp." , the system will automatically switch between cooling and heating functions, based on the outdoor ambient temperature: When Ambient temperature is lower than value set in parameter 4, unit activate heating operation. When Ambient temperature is higher than value set in parameter 5, unit activate cooling operation.

If setting="via. External Signal", an external room thermostat or central control system in the building can control the cooling or heating requirements by connecting it to the respective signal ports. The signals are simple 1-0 (on-off) signals

3. USEAGE

If cooling port receives the signal, the system switches to cooling; If heating port receives the signal, the system switches to heating. When neither port receives the signal, the system stays in standby mode.

Note: If system has a very big buffer tank for both cooling and heating operation, please pay special attention to set "Auto" to "via. Ambient Temperature". Otherwise it may waste lots of energy in Spring or Autumn, as unit may need to switch between cooling and heating operation quite often.

Parameter No.	Meaning	Range	Default Value
6	Shifting Priority	-20 - 20, 100 (stands for invalid)	-5

Air to water heat pump is an equipment that absorbs heat from surrounding air, and transfers it to water. The lower the ambient temperature is, the less heat the unit absorbs. This makes the unit heating capacity and efficiency drop when ambient temperature drops. The unit takes longer time to heat up the sanitary hot water. However, the lower the ambient temperature is, the more heat the house demands. If the unit does not provide enough heat while it is working for hot water, the temperature inside the house may drop too much, and people in it feels uncomfortable. So when this function is activated, unit tries to divide the working time for sanitary hot water into several cycles, after ambient temperature drops below this set value.

In Advanced Setting, there has more parametes related to the working of this function. For more details, please contact your installer or read chapter "Advanced Opeartion" in our manual.

Note: If this parameter is set to 100, it means this function is invalid. If it is set to any value other than 100, that means this function is activated and start to shifting priority after ambient temperature drops below this set value.

Parameter No.	Meaning	Range	Default Value
7	Set Room Temperature	10-31 (in °C)	20

Heating or cooling function has "Water Temperature Control" as default. However when a room temperature sensor is connected to the unit and a more precise control of room temperature where the sensor is placed is preferred, "Room Temperature Control" mode can be selected. And the ideal room temperature can be set via this parameter.

Note:When "Room Temperature Control" mode is selected, system will not operate under the heating curve function and actual water temperature may swing significantly.

【Heating Curve】

Group D

List of parameters

Parameter No.	Meaning	Range	Default Value
D1	Heating Curve Function	0(invalid), 1(valid)	1
D2	Room Temp. Effect On Heating Curve	0(invalid), 10 - 60(time period for every adjustment, in minutes)	0
D3	Ambient Temp. 1	-20 - 45 (in °C)	12
D4	Ambienttemp 1 Vs Water Temp. 1	20 - 65 (in °C)	25
D5	Ambient Temp. 2	-20 - 45 (in °C)	7
D6	Ambienttemp 2 Vs Water Temp. 2	20 - 65 (in °C)	28
D7	Ambient Temp. 3	-20 - 45 (in °C)	2
D8	Ambienttemp 3 Vs Water Temp. 3	20 - 65 (in °C)	31
D9	Ambient Temp. 4	-20 - 45 (in °C)	-7
DA	Ambienttemp 4 Vs Water Temp. 4	20 - 65 (in °C)	35
DB	Ambient Temp. 5	-20 - 45 (in °C)	-20
DC	Ambienttemp 5 Vs Water Temp. 5	20 - 65 (in °C)	42

3. USEAGE

Parameter No.	Meaning	Range	Default Value
D1	Heating Curve Function	0(invalid), 1(valid)	1

Heating Curve means let the system adjust the outlet water temperature based on the ambient temperature by continually monitoring and adjusting in opposite direction with the current ambient temperature levels according to a pre-set curve, to optimum comfort levels based on the changing heat demand, insulation levels, etc.

In a way, when it is colder (warmer) outside, house will need a higher (lower) temperature water to keep the same air temperature in the house. Thus we can set a curve for the unit to follow, to let the unit adjust its set temperature for heating operation according to the set curve and actual ambient temperature.

This function can be turned ON/OFF by adjusting the value of this parameter.

Parameter No.	Meaning	Range	Default Value
D2	Room Temp. Effect On Heating Curve	0(invalid), 10 - 60(time period for every adjustment, in minutes)	0

If room temperature sensor is connected, "Set Room Temperature" in "Temperature Parameter" under "Basic Operation" is set, and this "Room Temp. Effect On Heating Curve" is ON, unit will adjust the set water temperature (a set value or calculated value via heating curve), according to the difference between actual room temperature and ideal room temperature.

For example, if current water set temperature calculated according to the heating curve is 35°C:

If actual room temperature is 27°C, while "Set Room Temperature" is set to 22 °C, then the unit will deduct (27 °C-22 °C)=5 °C from water set temperature, which means unit will take 30 °C as the final set temperature.

Parameter No.	Meaning	Range	Default Value
D3	Ambient Temp. 1	-20 - 45 (in °C)	12
D4	Ambienttemp 1 Vs Water Temp. 1	20 - 65 (in °C)	25
D5	Ambient Temp. 2	-20 - 45 (in °C)	7
D6	Ambienttemp 2 Vs Water Temp. 2	20 - 65 (in °C)	28
D7	Ambient Temp. 3	-20 - 45 (in °C)	2
D8	Ambienttemp 3 Vs Water Temp. 3	20 - 65 (in °C)	31
D9	Ambient Temp. 4	-20 - 45 (in °C)	-7
DA	Ambienttemp 4 Vs Water Temp. 4	20 - 65 (in °C)	35
DB	Ambient Temp. 5	-20 - 45 (in °C)	-20
DC	Ambienttemp 5 Vs Water Temp. 5	20 - 65 (in °C)	42

Unit will create a heating curve according to these setting.

Parameter D3, D5, D7, D9 and DB are used to set 5 different ambient temperatures; Parameter D4, D6, D8, DA and DC are used to set 5 corresponding set water temperatures VS the set 5 ambient temperatures. Then a heating curve will be generated automatically.

Note: Value of parameter D3, D5, D7, D9 and DB should be in negative direction, or say in other way, D3>D5>D7>D9>DB, otherwise the setting of the value may not saved.

3. USEAGE

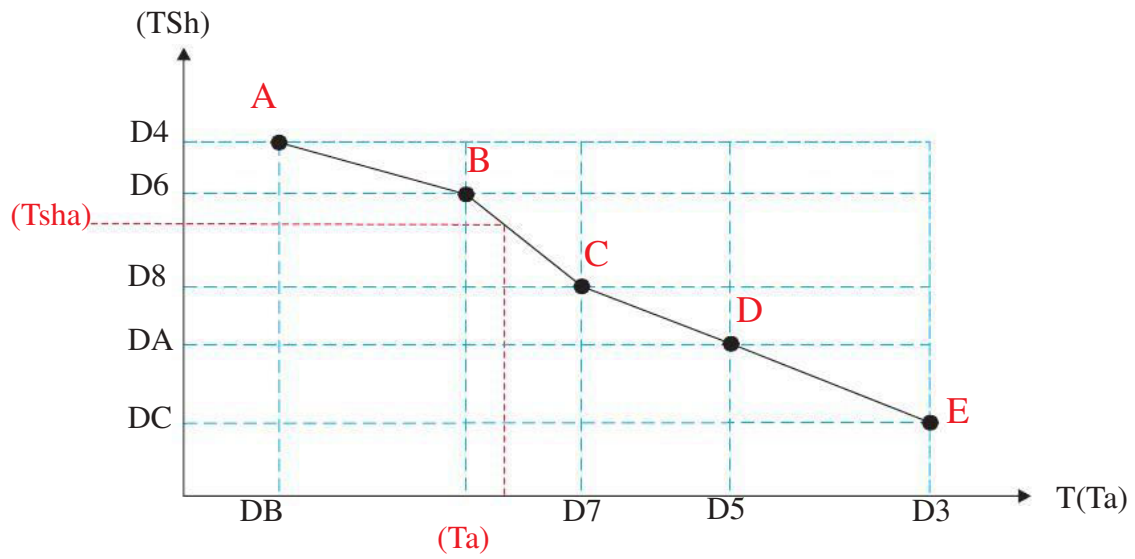

As shown here, actual set water temperature (TSh) is calculated according to actual ambient temperature (Ta), according to this created curve.

D9

3. USEAGE

3.4 Advanced Setting

Advanced setting is opened to installer or professional customer. It contains more functions and setting that can maximum the comfort and efficiency of the system. You need to enter the correct password to activate "Advanced Setting":

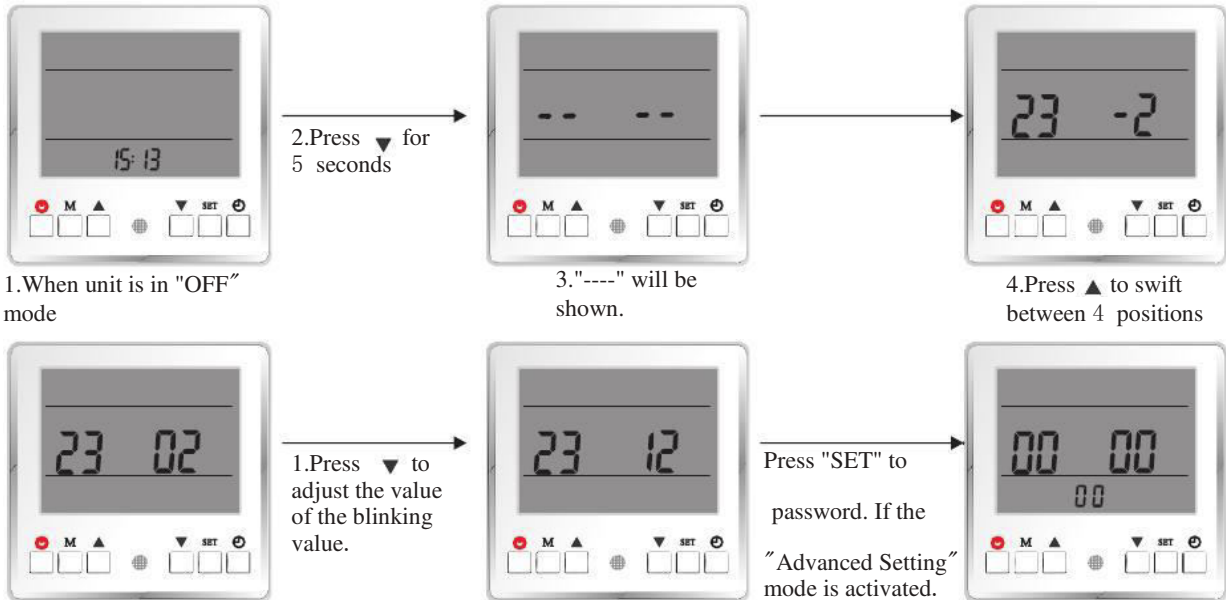

If the password is incorrect, it exits to OFF mode

Operation in Advanced Setting menu:

Complete Advanced Setting menu is divided into 6 groups (Group 0~Group E).

When Advanced Setting menu is activated, press to switch between each group (Group 0, A, B, C, D, E) .

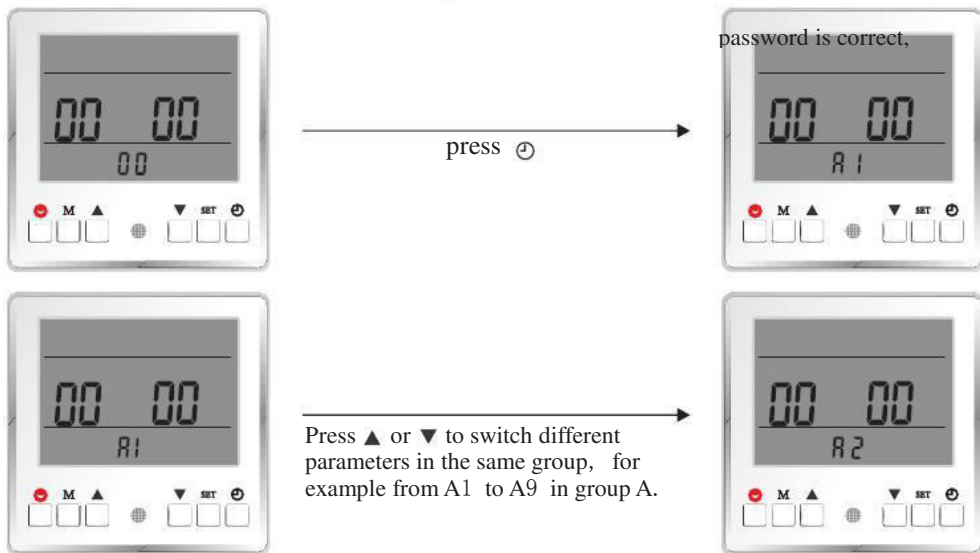

Press "SET" to activate setting of current parameter, with its value blinks.

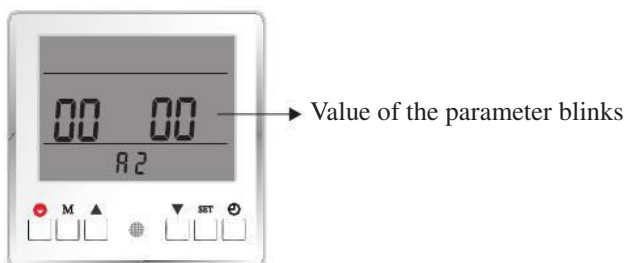

3. USEAGE

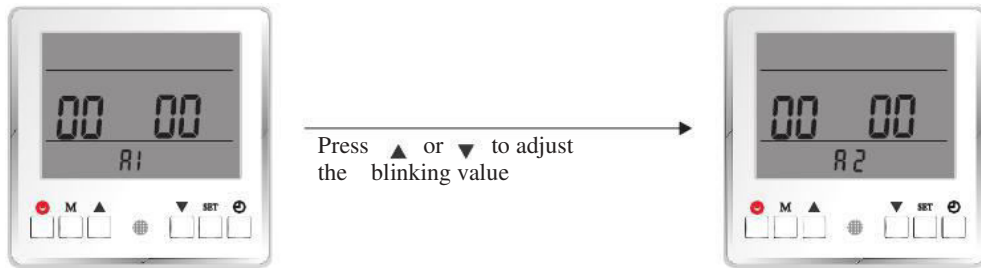

Press "SET" to confirm the setting. If no operation for 5 seconds, it exits to main interface without saving the setting.

【System Setting】

Group 0

List of parameters

Parameter No.	Meaning	Range	Default Value
0	Indoor Control System Working Mode	0 (normal), 1(testing)	0
1	External ON OFF Switch	0 (invalid), 1(valid)	0
2	Water Flow Switch	0 (invalid), 1 - 60 (checking time, in seconds)	60
3	Heating Buffer Tank	0(no), 1(yes)	0
4	Cooling Buffer Tank	0(no), 1(yes)	0
5	Priority Switch Between Hot Water and Heating Operation	0 (hot Water), 1(heating)	0
6	Refrigerant collecting function	0(off), 1(compressor System 1ON), 2(compressor System 2 ON)	0
7	Lock Function	00 - 99 (in weeks)	00

Parameter No.	Meaning	Range	Default Value
0	Indoor Control System Working Mode	0 (normal), 1(testing)	0

This function is designed for letting the installer test the output signals of the indoor control system. When this function is activated, indoor control system will activate the relay on the PCB when correspondent port on PCB is short-connected:

Port On PCB	Relay Output	Funtion
IP	EVC	3-way valve (Cooling/Heating Port)
IWT	EVW	3-way valve (Hot Water Port)
IH	HTH	Auxiliary Heater
IC	HTS	Heating Back-up Heater
IRES	HTW	Domestic Hot Water Back-up Heater
IP+IWT	PUMPH	Heating Distribution System Pump
IP+IH	PUMPC	Cooling Distribution System Pump
IP+IC	PUMPS	Unit Circulation Pump
IP+IRES	RHS	Preserved-1
IC+IH	YL	Preserved-2

3. USEAGE

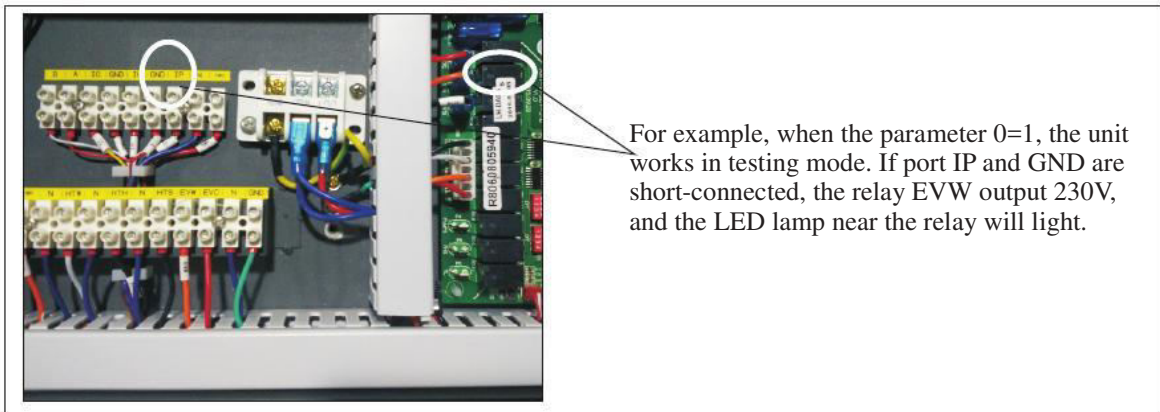

Parameter No.	Meaning	Range	Default Value
1	External ON OFF Switch	0 (invalid), 1(valid)	0

An external Close/Open signal from other control devices can be connected to the IP and GND port shown on the below picture on indoor PCB, to switch ON/OFF the working of complete heat pump unit, if this parameter is set to 1:

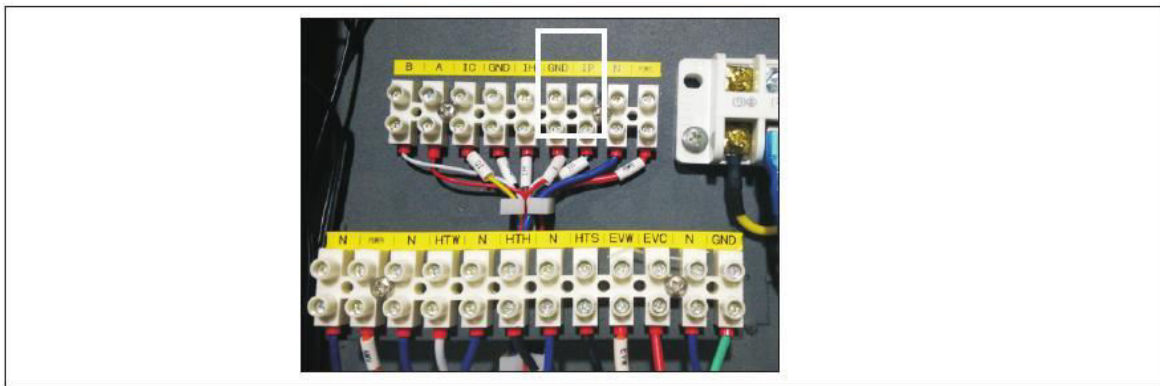

When the input external signal is "close" type, unit works ;
 When the input external signal is "open" type, unit stops.

Parameter No.	Meaning	Range	Default Value
2	Water Flow Switch	0 (invalid), 1 - 60 (checking time, in seconds)	60

This parameter is used to set whether the system has a water flow switch or not, and if yes, how many seconds after unit circulation pump starts, unit starts to check the statue of the water flow switch.

If it is set to "0", unit will not check the statue of the flow switch.

If it is set to any value except "0", unit starts to check the statue of flow switch after unit circulation pump starts for this set time. If flow switch is in "open" statue at this time, unit will show failure code E12, which means "not enough water flow rate".

Note:

If unit circulation pump is OFF, flow switch should in "open" statue as there should has no flow in the system. If not, unit will take it as the failure of flow switch itself, and give out correspondent failure code.

Parameter No.	Meaning	Range	Default Value
3	Heating Buffer Tank	0(no), 1(yes)	0

This parameter is used to set whether the system has a buffer tank for heating operation. It is more related to the control of "circulation pump for heating system".

If there has no buffer tank included in the heating system, circulation pump for heating system ” will work only when the unit works in heating mode. And the circulation pump works for 1 minute after stops for every 6 minutes to read the temperature in the distribution system.

If there has a buffer tank included in the heating system, "circulation pump for heating system" will work whenever the unit has the demand for heating operation.

3. USEAGE

Parameter No.	Meaning	Range	Default Value
4	Cooling Buffer Tank	0(no), 1(yes)	0

This parameter is used to set whether the system has a buffer tank for cooling operation. It is more related to the control of "circulation pump for cooling system".

If there has no buffer tank included in the cooling system, "circulation pump for cooling system" will work only when the unit works in cooling mode.

If there has a buffer tank included in the cooling system, "circulation pump for cooling system" will work whenever the unit has the demand for cooling operation.

Parameter No.	Meaning	Range	Default Value
5	Priority Switch Between Hot Water and Heating Operation	0 (hot Water), 1(heating)	0

This function is not designed for this model. Please don't set this parameter to 1.

Parameter No.	Meaning	Range	Default Value
6	Refrigerant collecting function	0(off), 1(compressor System 1ON), 2(compressor System 2 ON)	0

This function is used to pump all refrigerant back to outdoor unit in winter time for service purpose. For single compressor system or compressor system 1 of a dual compressor system, set this parameter to 1, to activate the refrigerant collecting function for compressor system 1. For activate the refrigerant collecting function for compressor system 2, set this parameter to 2.

After activated, compressor will start to work to pump the refrigerant back to outdoor unit. After work for 10 minutes, or press \odot button, this function stops in standby mode. Low ambient temperature protection and low current protection will not be checked under this operation.

Parameter No.	Meaning	Range	Default Value
7	Lock Function	00 - 99 (in weeks)	00

Attention: The usage of this function must comply with the local law or regulation system. Factory will not take any legal responsibility caused by the abuse of this function!!

This parameter is counted in weeks. Unit will be locked after set time is over, and can only be released by putting in the preset password.

How to set the pre-set password

Pre-set the password: In standby mode, Press \blacktriangle and "SET" at the same time for 5 seconds, "0000" will be shown on the screen. Press "SET" again to activate the setting of password. Press "UP" to swift between 4 positions, and press \blacktriangledown to adjust the value of the blinking value.

【Water Pump Setting】

Group A

List of parameters

Parameter No.	Meaning	Range	Default Value
A1	Unit Circulation Pump Control Type	0 (controlled by unit), 1 -15 (ON for set time, in minutes), 16(always ON)	0
A2	Heating Circulation Pump Control Type	0 (controlled by unit), 1 -15 (ON for set time, in minutes), 16(always ON)	0
A3	Cooling Circulation Pump Control Type	0 (controlled by unit), 1 -15 (ON for set time, in minutes), 16(always ON)	0

3. USEAGE

Parameter No.	Meaning	Range	Default Value
A4	Heating Circulation Pump Start Temperature	20 - 50 (in °C)	20
A5	Heating Circulation Pump Stop Temperature	20 - 50 (in °C)	18
A6	Cooling Circulation Pump Start Temperature	5 - 20 (in °C)	18
A7	Cooling Circulation Pump Stop Temperature	5 - 20 (in °C)	20
A8	Unit Motorized 3-way valve Switching Time	0 (Always ON), 1 - 600 (With power for the set time, in seconds)	120
A9	Heating Operation Motorized 3-way valve Direction	0 (Same as Hot Water Operation), 1 (Same as Cooling Operation)	1

Parameter No.	Meaning	Range	Default Value
A1	Unit Circulation Pump Control Type	0 (controlled by unit), 1 - 15 (ON for set time, in minutes), 16 (always ON)	0
A2	Heating Circulation Pump Control Type	0 (controlled by unit), 1 - 15 (ON for set time, in minutes), 16 (always ON)	0
A3	Cooling Circulation Pump Control Type	0 (controlled by unit), 1 - 15 (ON for set time, in minutes), 16 (always ON)	0

These three parameters are designed for manual turn ON the pump during installation or service work. When the parameter is set to any value other than 0, the correspondent pump will start to work immediately, and stop automatically after set time is finished.

This can be used to check the statue of the circulation pump, or circulate the water for air purging purpose before unit starts.

Parameter No.	Meaning	Range	Default Value
	Heating Circulation Pump Start Temperature	20 - 50 (in °C)	20
A5	Heating Circulation Pump Stop Temperature	20 - 50 (in °C)	
A6	Cooling Circulation Pump Start Temperature	5 - 20 (in °C)	
A7	Cooling Circulation Pump Stop Temperature		20

For heating operation, if water temperature is too low, it has no meaning to circulate this "cold" water into house heating distribution system.

Thus when heating circulation pump is OFF, it will only start to work when water temperature is higher than set "Heating Circulation Pump Start Temperature"; When heating circulation pump is working, it will stop if water temperature is lower than set "Heating Circulation Pump Stop Temperature".

For cooling operation, if water temperature is too high, it has no meaning to circulate this "hot" water into house cooling distribution system.

Thus when cooling circulation pump is OFF, it will only start to work when water temperature is low than set "Cooling Circulation Pump Start Temperature"; When cooling circulation pump is working, it will stop if water temperature is higher than set "Cooling Circulation Pump Stop Temperature".

3. USEAGE

Parameter No.	Meaning	Range	Default Value
A8	Unit Motorized 3-way valve Switching Time	0 (Always ON), 1 - 600(With power for the set time, in seconds)	120
A9	Heating Operation Motorized 3-way valve Direction	0 (Same as Hot Water Operation), 1(Same as Cooling Operation)	1

Parameter A8 is used to set the type of the motorized 3-way valve used to switch the direction of water flow in different working modes. If it is set to 0, it means two directions of the valve is controlled by "with" or "without" power. If it is set to any value other than 0, it means the valve takes this time to switch from one direction fully to the other direction.

In some special application, heating and hot water may use the same water circuit. In this way, one can set parameter A9 to 0, so unit has one water direction for both hot water and heating, and one direction for cooling only.

【Anti-legionella and Anti-freezing】

Group B

Parameter No.	Meaning	Range	Default Value
B1	Anti-Legionella Set Temperature	60 - 75 (in °C)	60
B2	Anti-Legionella Duration	10 - 60 (in minutes)	30
B3	Anti-Legionella Maximum Allowable Working Duration	10 - 240 (in minutes)	120
B4	Anti-freezing Function	0(Invalid), 1(valid)	1
B5	Anti-freezing Starting Ambient Temperature--Primary	5 - 10 (in °C)	5
B6	Anti-freezing Starting Ambient Temperature--Secondary	0 - 4 (in °C)	2
B7	Anti-freezing Ending Ambient Temperature--Secondary	0 - 10 (in °C)	5
B8	Anti-freezing Starting Water Temperature--Secondary	0 - 10 (in °C)	2
B9	Anti-freezing Ending Water Temperature--Secondary	5 - 20 (in °C)	15

Parameter No.	Meaning	Range	Default Value
B1	Anti-Legionella Set Temperature	60 - 75 (in °C)	75
B2	Anti-Legionella Duration	10 - 60 (in minutes)	30
B3	Anti-Legionella Maximum Allowable Working Duration	10 - 240 (in minutes)	180

If user uses sanitary hot water directly out from the hot water tank, for healthy purpose, it's requested to heat up the water inside the tank over 60°C (please refers to local regulations) for water sanitization once a week.

Note: ON/OFF of this function can be set in "Basic Operation" level via parameter setting.

When this function is ON, if in 7*24 hours time period, unit has not reached the set water temperature for "anti-legionella function" (set in Advanced Menu) even once, then unit will activate anti-legionella operation at "Anti--legionella function starting time".

Heat Pump will heat the water up to 55°C, and then use unit Auxiliary Heater or Hot Water Back-up Heater to get the set "Anti-Legionella Set Temperature", and keep this temperature for "Anti-Legionella Duration" time, Anti-Legionella operation is finished successfully.

If after working over "Anti-Legionella Maximum Allowable Working Duration", Anti-Legionella operation still has not finished successfully, unit will be forced to end Anti-Legionella operation.

3. USEAGE

Parameter No.	Meaning	Range	Default Value
B4	Anti-freezing Function	0(invalid), 1(valid)	1
B5	Anti-freezing Starting Ambient Temperature--Primary	5 - 10 (in °C)	5
B6	Anti-freezing Starting Ambient Temperature--Secondary	0 - 4 (in °C)	2
B7	Anti-freezing Ending Ambient Temperature--Secondary	0 - 10 (in °C)	5
B8	Anti-freezing Starting Water Temperature--Secondary	0 - 10 (in °C)	2
B9	Anti-freezing Ending Water Temperature--Secondary	5 - 20 (in °C)	15

Anti-freezing function can be activated, to protect the unit from damage caused by water freezing inside the unit.

Note: If unit is out of power, or water circuit is blocked, anti-freezing protection will not function properly. Anti-freezing protection doesn't means the anti-freezing protection for all water system in the house.

Please apply other necessary anti-freezing protections in your house, to protect the house from damage caused by freezing.

When unit is OFF and anti-freezing protection is valid, if ambient temperature is lower than the "Anti-freezing Starting Ambient Temperature--Primary", unit activate primary anti-freezing protection. Circulation pump will be forced to work occasionally.

When unit is OFF and anti-freezing protection is valid, if ambient temperature is lower than "Anti-freezing Starting Ambient Temperature--Secondary", if water outlet temperature is lower than "Anti-freezing Starting Water Temperature--Secondary", compresor will be forced to work, until water outlet temperature is higher than "Anti-freezing Ending Water Temperature--Secondary", or ambient temperature is higher than "Anti-freezing Ending Ambient Temperature--Secondary".

【Backup Heating】

Group C

List of parameters

Parameter No.	Meaning	Range	Default Value
C1	Manual ON/OFF of Heater in Hot Water Mode	0(invalid), 1(valid)	0
C2	Backup Heating Source For Hot Water Mode	0(no), 1(yes)	0
C3	Priority Of Backup Heating Sources For Hot Water Mode (Compared With Unit Auxiliary Heater)	0(lower), 1(higher)	0
C4	Temperature Increasement Checking Duration in Hot Water Mode	1 - 20(in minutes)	40
C5	Maximum Allowable Set Water Temperature in Heating Mode	0 (not exceeds compressor maximum allowable water temperature), 40 - 65 (maximum allowable set water temperature in heating mode)	42
C6	Manual ON/OFF of Heater in Heating Mode	0(invalid), 1(valid)	0
C7	Backup Heating Source For Heating Mode	0(no), 1(yes)	1
C8	Priority Of Backup Heating Sources For Heating Mode (Compared With Unit Auxiliary Heater)	0(lower), 1(higher)	1
C9	Accumulated Value between operation time VS set temp. for Heating Mode	0 - 600	45

3. USEAGE

Parameter No.	Meaning	Range	Default Value
C1	Manual ON/OFF of Heater in Hot Water Mode	0(invalid), 1(valid)	0

If heat pump unit meets a failure, extra heating source (unit "Auxiliary Heater" or "Backup Heating Source For Hot Water Mode" can be manually switched ON for heating up the shower water by set "Manual ON/OFF of Heater in Hot Water Mode" to ON.

Parameter No.	Meaning	Range	Default Value
C2	Backup Heating Source For Hot Water Mode	0(no), 1(yes)	0
C3	Priority Of Backup Heating Sources For Hot Water Mode (Compared With Unit Auxiliary Heater)	0(lower), 1(higher)	0
C4	Temperature Increasement Checking Duration in Hot Water Mode	1 - 20(in minutes)	40

If there has a "Backup Heating Source For Hot Water Mode" connected, it can be put under the control of the unit by set "Backup Heating Source For Hot Water Mode" to ON.

And, as both "Backup Heating Sources For Hot Water Mode" and unit "Auxiliary Heater" can both be used as extal heating source for hot water mode, the "Priority Of Backup Heating Sources For Hot Water Mode (Compared With Unit Auxiliary Heater)" can be set, to choose "Backup Heating Sources For Hot Water Mode" or unit "Auxiliary Heater" is preferred to be activated first.

When:

Hot Water Temperature increasement in "Temperature Increasement Checking Duration in Hot Water Mode" is not enough and actual water temperature is not over 55°C, unit will activate the higher priority extra heating source first. If increasement is still not enough, unit will activate the lower priority extra heating source also.

If set and actual hot water temperature is over 55°C, unit will activate the higher priority extra heating source.

In this case, if "Backup Heating Source For Hot Water Mode" has higher priority, as it doesn't need to use the unit water circulation, heat pump unit will turn to heating or cooling operation to maximum the usage of heat pump.

Parameter No.	Meaning	Range	Default Value
C5		0 (not exceeds compressor maximum allowable water temperature in heating mode)	42

In heating mode, compressor can only work till maximum 55°C water temperature. But in some real cold days, this temperature may still not enough for keep heating up the house, then a higher allowable temperature can be set here, to the unit can use extra heating source (unit Auxiliary Heater or Back Heating Source For Heating Mode) to ensure the comfort of heating operation.

Note: This function should only be used if water temperature really need to be over 55°C to heat up the house. If not, it will waste energy as most of the heating may carried by extra heating source.

If floor heating is used as distribution system, please be sure the water flow into floor heating system not exceed the maximum allowable water temperature for floor heating system, otherwise it may get damaged. It can be controlled by set this parameter to a safety value, or add safety regulations at inlet of a floor heating system.

Parameter No.	Meaning	Range	Default Value
C6	Manual ON/OFF of Heater in Heating Mode	0(invalid), 1(valid)	0

If heat pump unit meets a failure, extra heating source (unit "Auxiliary Heater" or "Backup Heating Source For Heating Mode" can be manually switched ON for heating up the house by set "Manual ON/OFF of Heater in Heating Mode" to ON.

3. USEAGE

Parameter No.	Meaning	Range	Default Value
C7	Backup Heating Source For Heating Mode	0(no), 1(yes)	1
C8	Priority Of Backup Heating Sources For Heating Mode (Compared With Unit Auxiliary Heater)	0(lower), 1(higher)	1
C9	Accumulated Value between operation time VS set temp. for Heating Mode	0 - 600	45

If there has a "Backup Heating Source For Heating Mode" connected, it can be put under the control of the unit by set "Backup Heating Source For Heating Mode" to ON.

And, as both "Backup Heating Sources For Heating Mode" and unit "Auxiliary Heater" can both be used as extal heating source for heating mode, the "Priority Of Backup Heating Sources For Heating Mode (Compared With Unit Auxiliary Heater)" can be set, to choose "Backup Heating Sources For Heating Mode" or unit "Auxiliary Heater" is preferred to be activated first.

When:

Unit capacity is not enough ("Accumulated Value between operation time VS set temp. for Heating Mode" over the set value), or actual and water temperature is over 55 °C, unit will activate the higher priority extra heating source first.

If totally heating capacity is still not enough ("Accumulated Value between operation time VS set temp. for Heating Mode" over the set value again), unit will activate the lower priority extra heating source also.

【Heating Curve】

Group D

Please check the introduction on page 62.

【Heat Recovery and Shifting Priority】

Group E

List of parameters:

Parameter No.	Meaning	Range	Default Value
E1	Heat Recovery Function	0(invalid), 1(valid)	0
E2	Hot Water Restart Based On ΔT in Heat Recovery Operation	5 - 10 (in °C)	5
E3	Hot Water Stop Based On ΔT in Heat Recovery Operation	1 - 10 (in °C)	5
E4	Allowable Temp Drift In Heating in Shifting Priority Operation	3 - 20 (in °C)	5
E5	Heating Max. Working Hours in Shifting Priority Operation	20 - 180 (in minutes)	30
E6	Hot Water Min. Working Hours in Shifting Priority Operation	20 - 180 (in minutes)	50
E7	Working of Extra Heating Source for Hot Water in Shifting Priority Operation	0 (no), 1(yes)	0

Parameter No.	Meaning	Range	Default Value
E1	Heat Recovery Function	0(invalid), 1(valid)	0
E2	Hot Water Restart Based On ΔT in Heat Recovery Operation	5 - 10 (in °C)	5
E3	Hot Water Stop Based On ΔT in Heat Recovery Operation	1 - 10 (in °C)	5

3. USEAGE

These parameters are valid only for the units with heat recovery function. For the unit without this function, "Heat Recovery Function" should always set to 1 (invalid).

If it is set to ON, unit will try to heat up the hot water by recover the wasted heat in heating and cooling operation. It will turn ON heat recovery circuit if actual hot water temperature is "Hot Water Restart Based On ΔT in Heat Recovery Operation" lower than set hot water temperature, and stop after it heat the hot water to "Hot Water Stop Based On ΔT in Heat Recovery Operation" over set hot water temperature.

If 1 hour before "Normal Shower Time" set in "Time and Timer Setting" under Basic Operation , hot water temperature has still not reached the set value, unit will activate standard hot water operation to ensure you can enjoy enough hot shower water at/after this time.

Parameter No.	Meaning	Range	Default Value
E4	Allowable Temp Drift In Heating in Shifting Priority Operation	3 - 20 (in °C)	5
E5	Heating Max. Working Hours in Shifting Priority Operation	20 - 180 (in minutes)	30
E6	Hot Water Min. Working Hours in Shifting Priority Operation	20 - 180 (in minutes)	50

If "Shifting Priority" function is turned ON in "Temperature Parameter" setting under Basic Operation, when actual ambient temperature is lower than "Shifting Priority" setting, Shifting Priority function will be activated.

Unit will firstly work in Hot Water Mode. If it gets the set temperature for hot water, or it has been working in Hot Water Mode over "Hot Water Min. Working Hours in Shifting Priority Operation", and temperature for heating has dropped over "Allowable Temp Drift In Heating in Shifting Priority Operation" based on set heating temperature, unit switch to heating. After switch to heating operation, if it gets the set temperature for hot water, or it has been working in heating operation for over " Heating Max. Working Hours in Shifting Priority Operation", unit switch back to hot water. This process will repeat continuously

Working Procedure of Shifting Priority Function:

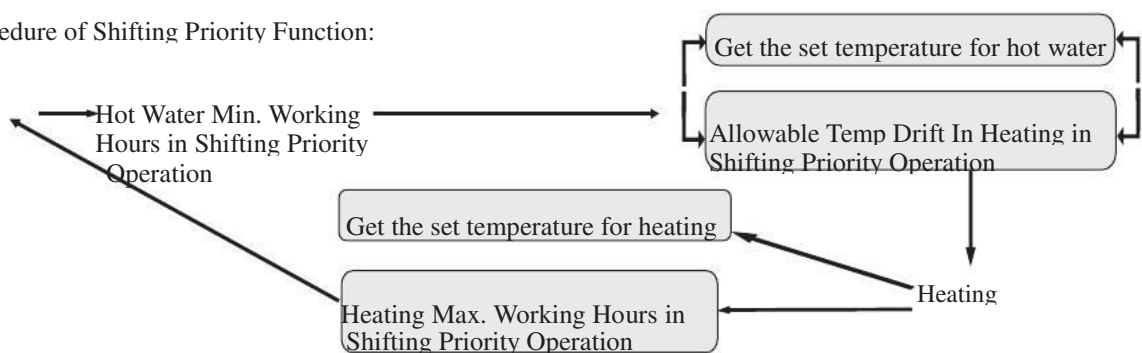

Parameter No.	Meaning	Range	Default Value
	Working of Extra Heating Source for Hot Water in Shifting Priority Operation	0 (no), 1(yes)	0

In shifting priority operation, when the unit switches to heating , this function can be activated to turn on extra heating source for hot water, and help to reach the set temperature for hot water.

If Parameter E7 is set as 1, the extra heating source for hot water will turn on when unit switches to heating in shifting priority operation.

If Parameter E7 is set as 0, the extra heating source for hot water will turn off when unit switches to heating in shifting priority operation.

Note: The extra heating source for hot water should be connected to the port HTW on the indoor PCB to activate the function. For AWT model, this function is invalid, because 1.5KW electric heater inside the water tank is controlled by digital thermostat directly, and there is no other heating source connected to HTW port.

3. USEAGE

3.5 Failure code

When unit is in ON/OFF mode and has some failure, which part has this failure and the failure code will be shown as follows:

- 00: indoor unit
- 01: compressor system 1
- 02: compressor system 2
- 03: Wired controller

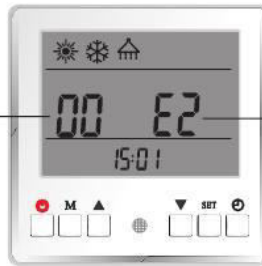

Failure code or protection code

3. USEAGE

3.6 Error code

【Failure for outdoor unit】

Type	Code	Failure	Unit working status	Unit working status
Protection	P01	Main line current protection	Comprssor stops	Input current too high or too low, or system works in over-load condition. Unit recovers automatically after 5 minutes when it happened the first time. If same failure happened 3 times in a certain period of time, unit stops until repowered. Check unit input current. Check whether fan motor and water pump is working OK; whether condensor is blocked; whether water temperature too high, and whether water inlet&outlet temperature has too big difference (should no bigger than 8°C)
	P02	Compressor phase current protection	Comprssor stops	Compressor input current too high or too low, or system works in over-load condition. Check compressor input current. Check whether fan motor and water pump is working OK; whether condensor is blocked; whether water temperature too high, and whether water inlet&outlet temperature has too big difference (should no bigger than 8°C)
	P03	IPM module protection	Comprssor stops	Compressor drive failure. Check whether cable is broken or loosen. Check whether compressor driver PCB or compressor is broken.
	P04	Compressor oil return protection	Compressor speed up	If unit has been continuously working in low speed for certain period of time, unit starts this protection to suck compressor oil back into compressor. This is a normal protection and doesn't need any treatment.
	P05	Compressor shut down due to high/low pressure switch open caused by abnormal high/low pressure	Comprssor stops	If system pressure is too high or too low, it activates this protection. Unit recovers automatically after 5 minutes when it happened the first time. If same failure happened 3 times in a certain period of time, unit stops until repowered. Check whether fan motor and water pump is working OK; whether condensor is blocked; whether water temperature too high, and whether water inlet&outlet temperature has too big difference (should no bigger than 8°C)
	P06	Compressor speed down due to abnormal high pressure detected by condensing pressure sensor	Compressor speed down	This protection happens when system pressure is higher than the set compressor speed-down pressure point. If after slow down the compressor speed but pressure still higher than the protection point, compressor stops. Check whether water temperature set value is too high; whether system water flow rate too small; whether EEV works normally; whether air circulates fluently in cooling mode; whether water inlet&outlet temperature has too big difference (should no bigger than 8°C)
	P07	Compressor preheating	Standard function, doesn't need any treatment.	This is a normal protection and doesn't need any treatment. When compressor did not work for long time and ambient temperature is low, compressor crankcase heater work for certain period of time before compressor start to warm up the compressor.
	P08	Compressor discharge temp. too high protection	Comprssor stops	Check whether water temperature set value is too high, especially when ambient temperature is low; whether water flow rate too small; whether system is lacking of enough refrigerant.

3. USEAGE

【Failure for outdoor unit】

Type	Code	Failure	Unit working statue	Unit working statue
Protection	P09	Outdoor evaporator coil temp. sensor protection	Comprssor stops	Check whether air circulates fluently in outdoor unit.
	Pa	AC over high/low voltage protection	Comprssor stops	Unit input voltage too high or too low. Check the voltage of unit power supply.
	Pb	Compressor shut down due to too high/low ambient temperature	Comprssor stops	Ambient temperature is too high or too low for unit to work.
	Pc	Compressor speed limit due to too high/low ambient temperature	Compressor speed down	This is a normal protection and doesn't need any treatment.
	Pd	Preserved	Preserved	Preserved
Failure	F01	Outdoor ambient temp. sensor failure	Comprssor stops	Check whether ambient temperature sensor is open, short-circuit or value drifts too much. Replace it if necessary.
	F02	Outdoor evaporator coil temp. sensor failure	Comprssor stops	Check whether outdoor coil temperature sensor is open, short-circuit or value drifts too much. Replace it if necessary.
	F03	Compressor discharge temp. sensor failure	Comprssor stops	Check whether compressor discharge temperature sensor is open, short-circuit or value drifts too much. Replace it if necessary.
	F04	Outdoor Suction temp. sensor failure	Comprssor stops	Check whether outdoor suction temperature sensor is open, short-circuit or value drifts too much. Replace it if necessary.
	F05	Evaporating pressure sensor failure	Comprssor stops	Check whether evaporating temperature sensor is open, short-circuit or broken. Replace it if necessary.
	F06	Condensing pressure sensor failure	Comprssor stops	Check whether condensing temperature sensor is open, short-circuit or broken. Replace it if necessary.
	F07	High/low pressure switch failure	Comprssor stops	If pressure switch is in open position when unit is in standby statue, or 2 minutes after compressor stops, unit gives this failure. Check whether high or low pressure switch is broken or not well connected.
	F08	Preserved	Preserved	Preserved
	F09	DC fan failure (one)	Comprssor speed down	Speed of DC fan or one of the DC fan (for dual fan system) can't reach the required value or no feedback signal. Please check whether the PCB or fan motor is broken.
	Fa	DC fan failure (two)	Comprssor stops	Speed of both DC fans (for dual fan system) can't reach the required value or no feedback signal. Please check whether the PCB or fan motor is broken.
		too low System evaporating pressure	Comprssor stops	If system too low pressure protection detected by evaporating pressure sensor happened 3 times in a certain period of time, it gives this failure code and unit system has not enough refrigerant or leakage inside (more likely it is not enough refrigerant that caused this abnormal evaporating pressure); whether fan motor and blocked; whether EEV whether EEV works normally; whether water temperature too low, and whether water inlet&outlet temperature has too big difference in cooling(should no bigger than 8°C).

3. USEAGE

【Failure for outdoor unit】

Type	Code	Failure	Unit working statue	Unit working statue
Failure		System condensing pressure too high	Comprssor stops	If system too high pressure protection detected by condensing pressure sensor happened 3 times in a certain period of time, it gives this failure code and unit can't be restarted until repowered. Check whether water flow rate is not enough (more likely it is not enough water flow rate that caused system build up too high pressure); whether fan motor and water pump is working OK; whether condensor is blocked; whether EEV works normally; whether water temperature too high, and whether water inlet&outlet temperature has too big difference (should no bigger than 8°C)
	F31	Preserved	Preserved	Preserved
System failure		Communication between opeartion panel and indoor PCB or outdoor PCB failure	Comprssor stops	Communication failure between operation panel and the indoor or outdoor PCB. Check the cable connection in between. Check whether the last three switches on outdoor power PCB are set to 001; whether last three switches on indoor PCB are set to 001. Unit recovers when communication recovers.
	E02	Outdoor power PCB and driver PCB communication failure	Comprssor stops	Check the communication cable between outdoor power PCB and deiver PCB. Check whether outdoor power PCB and deiver PCB is broken.
	E03	Compressor phase current failure (open/short circuit)	Comprssor stops	Check whether the power cable to compressor is broken or short-circuit.
	E04	Compressor phase current overload (over current)	Comprssor stops	Check whether the power cable to compressor is broken or short-circuit.
	E05	Compressor driver failure	Comprssor stops	Check whether compressor drive PCB is broken, or cable to compressor is wrong connected.
	E06	Module VDC over high/low voltage failure	Comprssor stops	Input voltage too high or too low.
	E07	AC current failure	Comprssor stops	Check the current to outdoor unit, and compare it with the unit current shown on the operation panel. If the difference is not big, check whether thesystem has enough refrigerant (more likely it is not enough refrigerant that caused this abnormal low current). If the difference is big, outdoor power PCB is broken. Please replace it with a new one;
	E08	EEPROM failure	Comprssor stops	Cut the unit power and short-circuit JP404 port on outdoor power PCB, repower the unit, cut power again and cancel the short-circuit on JP404 port. If still not OK, replace the outdoor power PCB.

【Failure for indoor unit】

Type	Code	Failure	Unit working statue	Unit working statue
Failure	E01	Ambient temp. sensor failure	1. Cooling operation is limited. 2.Cooling and heating auto-switch is not available. 3.Unit will use compressor discharge temperature as reference for anti-freezing protection. 4. Bivalent function is not available.	Check whether ambient temperature sensor is open, short-circuit or value drifts too much. Replace it if necessary.

3. USEAGE

【Failure for indoor unit】

Type	Code	Failure	Unit working statue	Unit working statue
Failure	E02	Sanitary hot water temp. sensor failure	Sanitary hot water mode is not available.	Check whether sanitary hot water temperature sensor is if necessary.
	E03	failure	available.	open, short-circuit or value drifts too much. Replace it if necessary.
	E04	Cooling water temp. sensor failure	Cooling mode is not available.	Check whether cooling water temperature sensor is if necessary.
	E05	failure		Check whether unit water outlet temperature sensor is open, short-circuit or value drifts too much. Replace it if necessary.
	E06	failure		Check whether unit water inlet temperature sensor is if necessary.
	E07	sensor failure		Check whether indoor coil temperature sensor of system 1 is open, short-circuit or value drifts too much. Replace it if necessary.
	E08	sensor failure		For dual compressor system: check whether indoor coil value drifts too much. Replace it if necessary. For single compressor system: check dip-switch number DIP2-1. It should be in OFF position.
	E09		of control	
	Ea	Indoor EEPROM failure	Unit keep on working	Reset EEPROM setting. If still not OK, replace the indoor PCB, unit will reset EEPROM automatically. After done, LED light for indicating the statue of relay "YL" will be powered. Repower the unit.
	Eb	failure		flow rate. Check the water system, especially the filter; check the working statue of water pump.
Ec	Water flow switch failure	Compressor stops	switch is broken or not well connected.	
Protection	P01	protection		Communication data lost too much. Check whether whether communication cable is longer than 30M; whether there has a source of the disturbance nearby the unit. Unit recovers when communication recovers.
	P02	protection		communication cable is correctly connected; check whether communication cable is longer than 30M; whether there has a source of the disturbance nearby
	P03	Operation panel communication protection	Warning but unit keeps on working	the unit. Unit recovers when communication recovers.
	P04	Master unit communication protection	Heating mode is not Unit stops	Check whether heating water temperature sensor is. Communication data lost too much. Check whether communication cable is correctly connected; check whether communication cable is longer than 30M; whether there has a source of the disturbance nearby

Unit water outlet temp. sensor

Unit water inlet temp. sensor

open, short-circuit or value drifts too much. Replace it

System 1 indoor coil temp.

System 1 stops

3. USEAGE

【Failure for indoor unit】

Type	Code	Failure	Unit working statue	Unit working statue
Failure	P05	System 1 indoor anti-freezing protection in cooling	Compressor of system 1 speed down or stop	1. Check whether set temperature for cooling is too low; whether system has too small water flow rate; check water system especially the filter.2.Check whether the evaporating pressure. 3.Check whether ambient temperature is lower than 15°C.
	P06	System 2 indoor anti-freezing protection in cooling	Compressor of system 2 speed down or stop	1. Check whether set temperature for cooling is too low; whether system has too small water flow rate; check system has not enough refrigerant inside by measuring the evaporating pressure. 3.Check whether ambient temperature is lower than 15°C.
		Too small water flow rate protection	Unit will restart after 3 minutes	flow rate. If the same protection happens over 3 times in certain period of time, unit will not restart and show "too small water flow rate failure". Check the water water pump.
	P08	Water outlet Temp. too low protection in cooling	Compressor stops	Compressor stops if water outlet is lower than 5°C in cooling mode. Check whether temperature sensor Tc is OK and well connected; whether set water temperature too low; whether system flow rate too small.
	P09	Water outlet Temp. too high protection in heating/hot water	Compressor stops	Compressor stops if water outlet is higher than 57°C in sensor Tc and Tw is OK and well connected; whether set water temperature too high; whether system flow rate too small.
	Pa	System 1 Water inlet Temp. too low protection in heating/hot water	Compressor of system 1 stops and auxiliary heater starts	inlet temperature is too low°C in heating and hot water mode. Compressor restarts when this temperature raise up. This is a protection for protecting the safety of the hot water mode may kill the compressor.
	Pb	System 1 Water inlet Temp. too low protection in heating/hot water	Compressor of system 2 stops and auxiliary heater starts	Compressor stops and auxiliary heater works if water inlet temperature is too low°C in heating and hot water up. This is a protection for protecting the safety of the compressor, as too low water temperature in heating or hot water mode may kill the compressor.
	Pc		in every 10 minutes	system has not enough refrigerant inside by measuring water temperature is low, water system has the risk of freezing up. Thus it is necessary to havethe circulation anti-freezing purpose.
	Pd	protection stage 2	automatically.	water system especially the filter.2.Check whether water temperature is too low, unit will start to work automatically to heat the water up to a minimum safe level. This is a minimum protection for protecting to System water flow rate is less than minimum allowable mode. Compressor restarts when this temperature raise up. Under conditions must be added according to the regulations to ensure the safety of water system.

【Failure for Wired Controller】

Type	Code	Failure	Unit working statue	Unit working statue
Failure	P3	communication protection	Circulation pump circulates for 1 minute Compressor stops	When unit is turned OFF, if ambient temperature and pump starts to circulate the water in the system, for please change the wired controller.

system, especially the filter; check the working statue of

When unit is turned OFF, if ambient temperature and

Unit working statue
pump starts to circulate the water in the system, for please change the wired controller.

When unit is turned OFF, if ambient temperature and heating or hot water mode. Check whether temperature well. Check if GND cable between indoor PCB and outdoor PCB are grounded. If all the cables are connected well, help preventing the water system from freezing up. Compressor stops and auxiliary heater works if water

3. USEAGE

【Outdoor PCB】

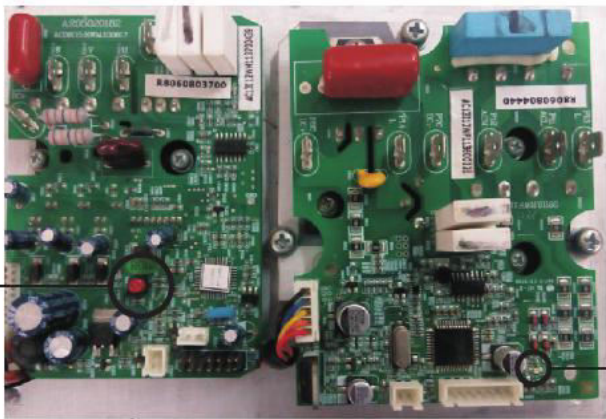

1. LED indicator light on Power PCB
 Factory Default Setting:
 Standby---flickers (2s ON, 2s OFF)
 On when unit is running
 Failure---flickers (0.5s ON, 2s OFF)

2. JP404 position of jumper for EEPROM programming or refreshing (this jumper must be taken out after programing, otherwise the unit can't work)

3. Connector for software burning tool

4. Dip switch on outdoor PCB
 Factory Default Setting:

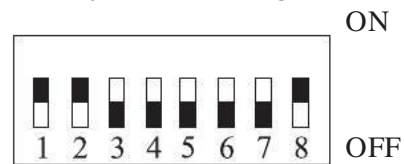

5/6. LED indicator light on outdoor Drive PCB in normal operation: flickers (2s ON, 2s OFF)

■ 4. MAINTENANCE

4.1 Attention

- 1) The user mustn't change the structure or wiring inside the unit.
- 2) The service and maintenance should be performed by qualified and well-trained technician. When the unit fails to run, please cut off power supply immediately.
- 3) The smart control system can automatically analyze various protection problems during daily use, and display the failure code on the controller. The unit may recover by itself. Under normal operation, the piping inside the unit don't need any maintenance.
- 4) In normal ambient conditions, the user only needs to clean the surface of the outdoor heat exchanger per month or quarter of a year.
- 5) If the unit runs in a dirty or oily environment, please clean the outdoor heat exchanger by professionals, using specified detergent, to ensure the performance and efficiency of the unit.
- 6) Please pay attention to the ambient environment, to check if the unit is installed firmly, or whether the air inlet and outlet of the outdoor unit is blocked.
- 7) Unless the water pump is damaged, no special service or maintenance should be taken to the water system inside the unit. It's recommended to clean water filter regularly or change it when it's very dirty or blocked.
- 8) If the unit will not be used in winter for a long time, please drain all the water inside the system, to prevent the water pipes from damage due to freezing.

4.2 Cleaning of water filter

The water filter should be cleaned according to the manual of water filter, to ensure the water flow of the water system. It is recommended that it be cleaned once in the first month, and then, once half a year.

4.3 Cleaning of plate heat exchanger

Thanks to the normally very high degree of turbulence in the heat exchanger, there is a self-cleaning effect in the channels. However, in some applications the fouling tendency can be very high, e.g. when using extremely hard water at high temperatures. In such cases it is always possible to clean the exchanger by circulating a cleaning liquid (CIP-Cleaning In Place). Use a tank with weak acid, 5% phosphoric acid or, if the exchanger is frequently cleaned, 5% oxalic acid. Pump the cleaning liquid through the exchanger. This work should be done by qualified person. For further information, please contact your supplier.

4. MAINTENANCE

4.4 Gas charging

The refrigerant plays an important role in delivering energy in cooling or heating. Insufficient refrigerant affects directly efficiency of cooling and heating. Please pay attention to the following before adding refrigerant:

- 1) The work should be done by professionals.
- 2) If the system has not enough refrigerant inside, please check whether the system has leakage inside. If yes, please repair it before gas charging, otherwise unit will lack of refrigerant again after working for a short period.
- 3) Don't add too much refrigerant than required, or it may cause a lot of failures, such as high pressure and low efficiency.
- 4) This system uses R410A refrigerant. It is strictly forbidden to charge any refrigerant other than R410A into the system.
- 5) There must be no air in the refrigerant circulation, because air will cause abnormal high pressure, which will damage the gas piping and lower heating or cooling efficiency.
- 6) If the refrigerant leaks inside the house, please keep windows open for few minutes even R410A refrigerant do no harm to health.
- 7) The steps are as follows:
Use 5/8" or 1/2" connector for gas charging and run the unit in cooling mode.

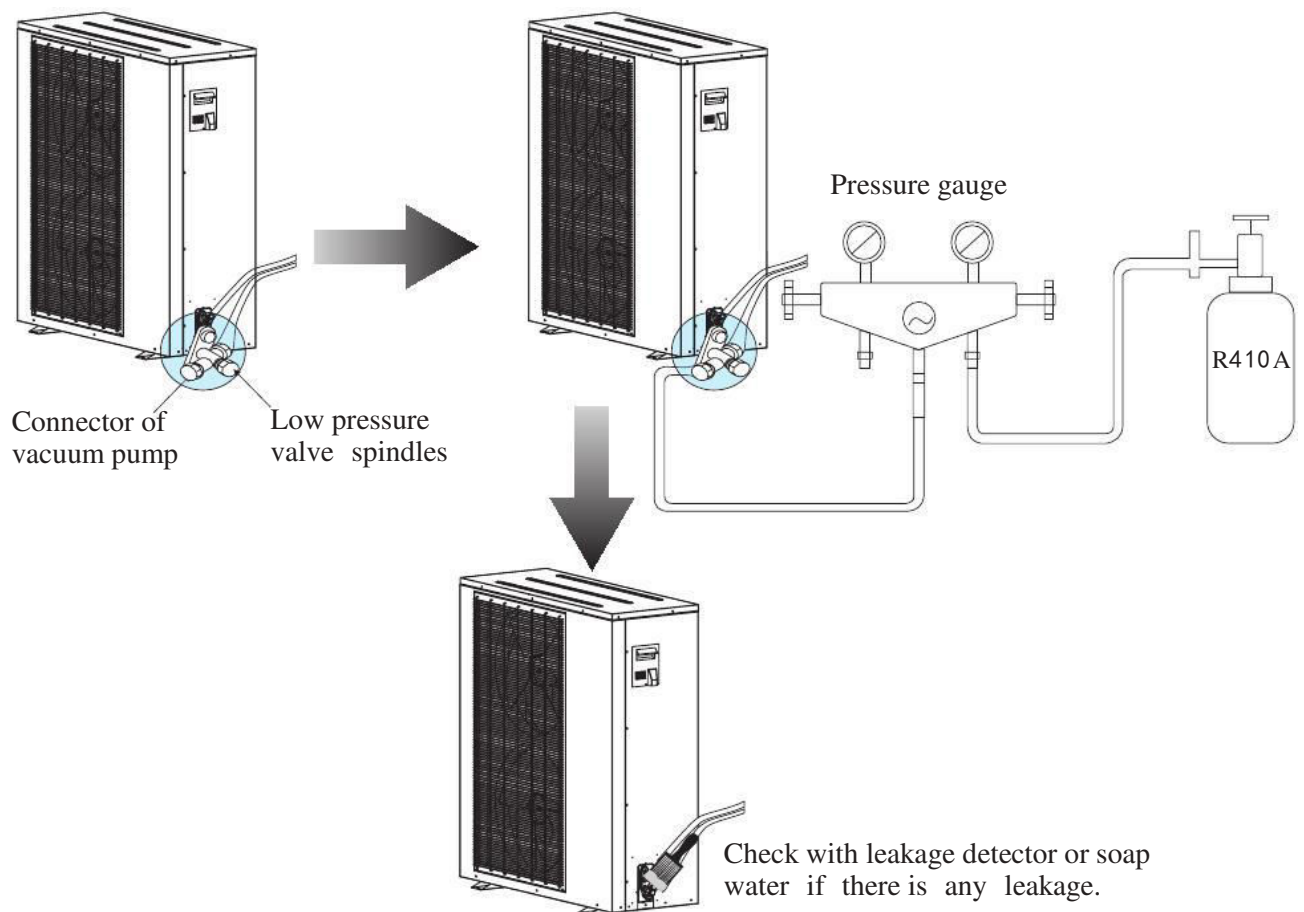

Note: Always use a weight scale to measure the gas amount charged into the unit.

4. MAINTENANCE

4.5 Condenser coil

The condenser coils do not require any special maintenance, except when they are clogged by paper or any other foreign objects. Cleaning is by washing with detergent and water at low pressure, and then rinsing with clean water:

- 1) Before cleaning, make sure the unit is off.
- 2) Inner of the unit must be cleaned by qualified person.
- 3) Do not use gasoline, benzene, detergent etc. to clean the unit. And do not spray with insecticide. Otherwise the unit may be damaged. The cleanser special made for air conditioner cleaning is recommended.
- 4) Spray air conditioner cleanser into the coils. Let the cleaner sit for 5-8 minutes.
- 5) Then, spray the coil with clean water.
- 6) An old hairbrush works well for brushing surface dirt and lint off the fins. Brush in the same direction as the slots between the fins so the bristles go between the fins.
- 7) After cleaning, use a soft and dry cloth to clean the unit.

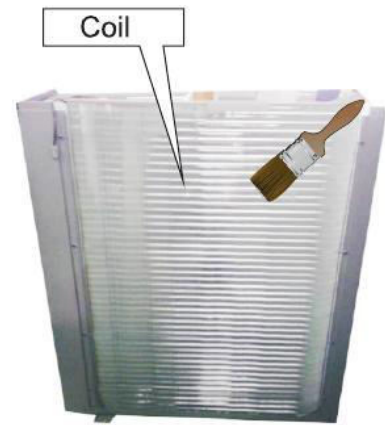

4.6 Service of outdoor unit

4.6.1 Maintenance of controller

- 1) Cut off the power supply, take off the top cover of the unit.
- 2) Take off the electric box cover.
- 3) Do necessary maintenance work to the controller of outdoor unit.

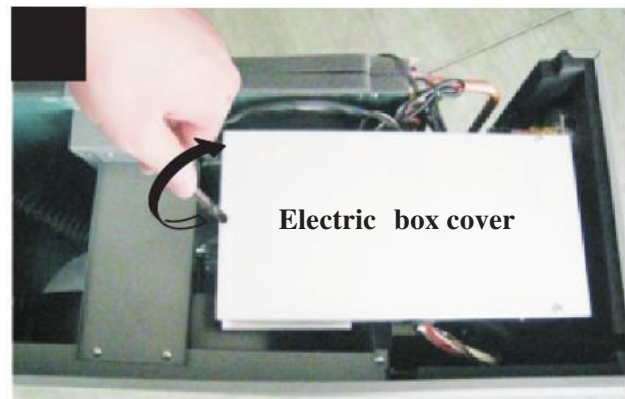
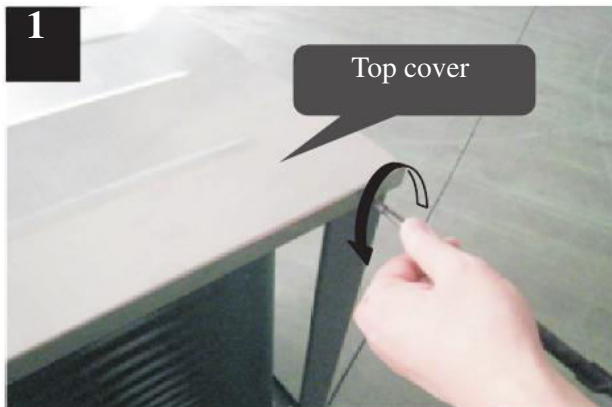

4. MAINTENANCE

4.6.2 Replacement of fan motor

- 1) Cut off the power supply, take off screws of the front grill.
- 2) Use a wrench to loosen the nut for fan blade and take out the fan blade.
- 3) Take off the screws of fan motor.
- 4) Plug out power cable for fan motor from PCB.
- 5) Put the repaired or new fan motor back and connect all cables back.



4. MAINTENANCE

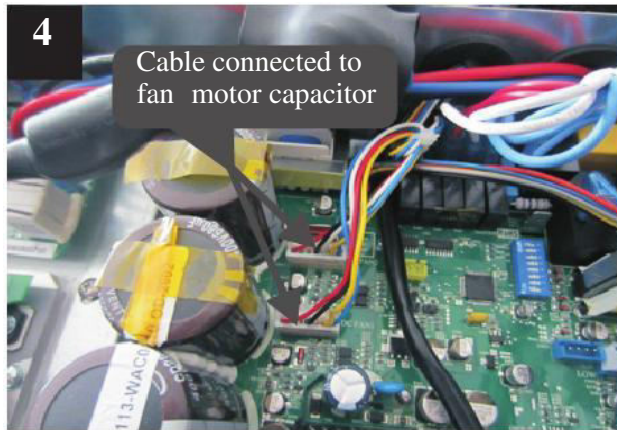

4. MAINTENANCE

4.6.3 Replacement of bottom plate heater

- 1) Cut off the power supply, follows 4.7.2 to take out the fan blade.
- 2) Take off the fixture of bottom plate heater(see picture 1).
- 3) Disconnect the quick connector for bottom plate heater and take the heater out (see picture 2).
- 4) Put a new bottom plate heater back, and connect it to the quick connector(see picture 3).

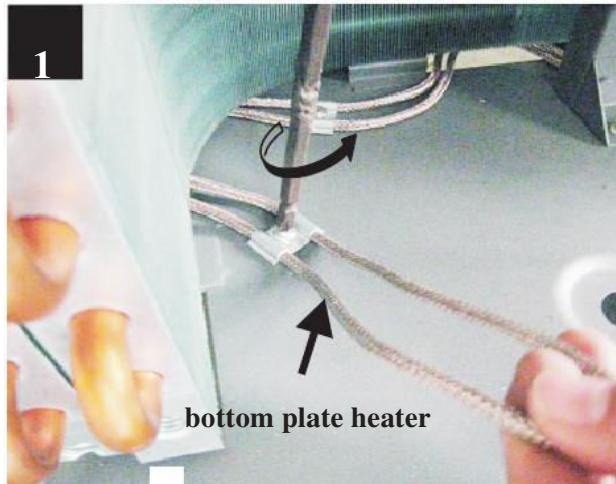

4. MAINTENANCE

4.7 Trouble shooting

Failure	Cause	Solution
Unit can't start up	1. No power supply	1. Check the power supply
	2. Fuse is broken or circuit breaker is disconnected	2. Check if it's open circuit or if the unit is earthed. Then change a fuse and reset the breaker, check if the circuit is stable or the connection is well.
	3. Some kind of protection works	3. Check which protection is working, and clear the protection, then restart the unit.
	4. Wiring is loose	4. Check the wire connection and tighten the screws on the terminal
	5. compressor fails	5. Change a compressor
Fan fails to run	1. Fan motor wire loose	1. Check the wire connections.
	2. fan motor failure	2. Change fan motor.
Low heating performance	1. The coil fins are very dirty	1. Clean the evaporator coil
	2. Air inlet is blocked	2. Remove any object that blocks the air circulation of the unit.
	3. Insufficient of refrigerant	3. Inspect the unit for leakage and fix it if any. Discharge all refrigerant and charge the unit again with correct amount.
Too high noise from the water pump, or no water flow when the water pump is running	1. Lacking of water in water system	1. Check the water filling device. Fill the system with enough water.
	2. Air exists in water system	2. Purging the air out.
	3. Valves in water system are not completely opened	3. Check all the valves to ensure they are fully opened.
	4. Water filter is dirty or blocked	4. Clean the water filter
Too high compressor discharge pressure	1. Too much refrigerant	1. Discharge all refrigerant and charge the unit again with right amount.
	2. Air exists in refrigeration system	2. Discharge all refrigerant and charge the unit again with right amount.
	3. Inadequate water flow	3. Check the water flow of the system. Use a bigger pump to increase the water flow if necessary.
	4. Too high water temperature	4. Check the value of the water temperature sensor, to ensure it works properly.
Too low suction pressure	1. Drier filter is blocked	1. Change a new one
	2. Electronic expansion valve is not opened	2. Repair or change a new one
	3. Leakage of refrigerant	3. Inspect the unit for leakage and fix it if any. Discharge all refrigerant and charge the unit again with right amount.
Unit can not defrost properly	1. Coil temperature sensor failure	1. Check the position and value of the coil temperature sensor. Replace it if necessary.
	2. Air inlet/outlet is blocked	2. Remove any object that blocks the air circulation of the unit. Clean the evaporator coil occasionally.

4.MAINTENANCE

The following phenomenon may not be problems of unit itself.
Please contact with a professional maintenance staff for help.

Number	Failure	Solution
1	The unit is not running	When the unit restarts, the compressor will start 3 minutes later (self-protection of compressor), please check if the circuit breaker is disconnected, and if there is normal power supply for the wire controller.
2	Low capacity	Check if the air inlet or outlet is blocked in outdoor unit; check if the setting temperature is too high in cooling mode, or too low in heating mode.

5. ATTACHED DRAWING

5.1 Outlines and dimensions

AWH9/11/13-V5+IIU

Indoor

unit:mm

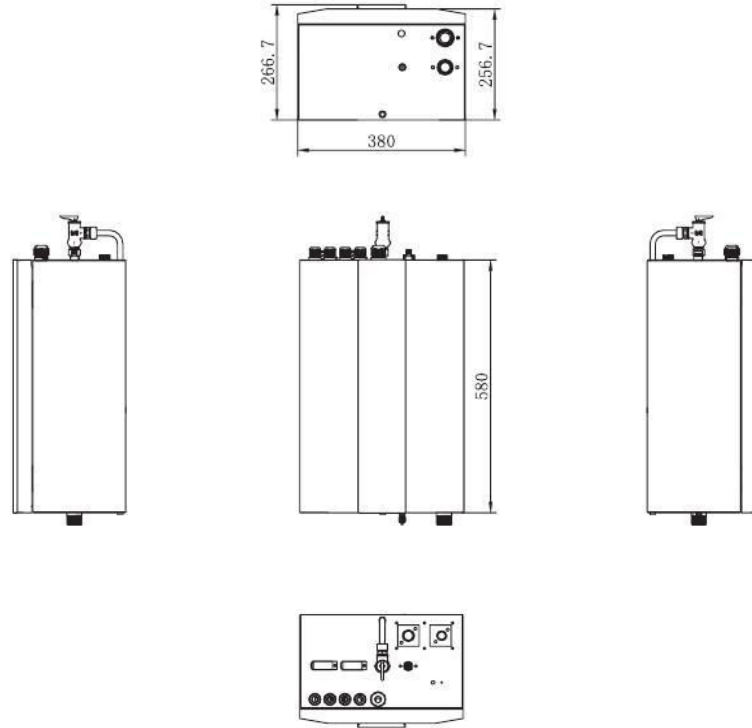

Outdoor

AW9-V5+IOU

Refrigerant connector
dimension: $\phi 9.52$ & $\phi 12.7$

unit:mm

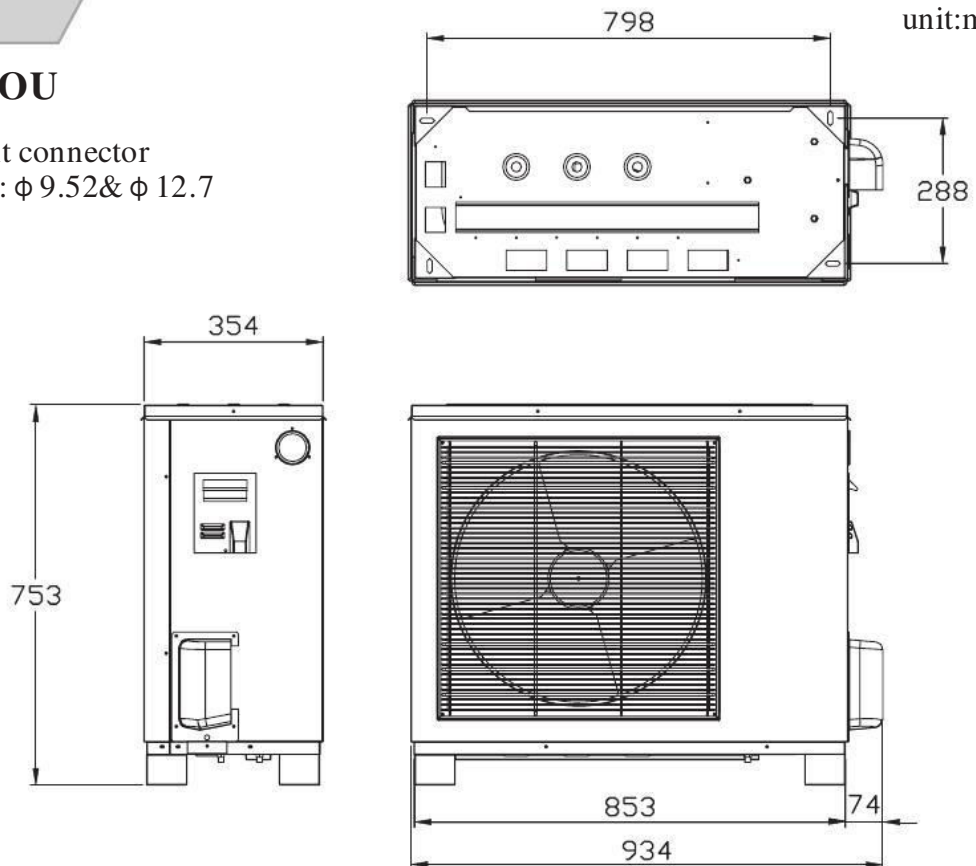

5. ATTACHED DRAWING

AW11-V5+IOU

Indoor

Refrigerant connector dimension: $\phi 9.52$ & $\phi 12.7$

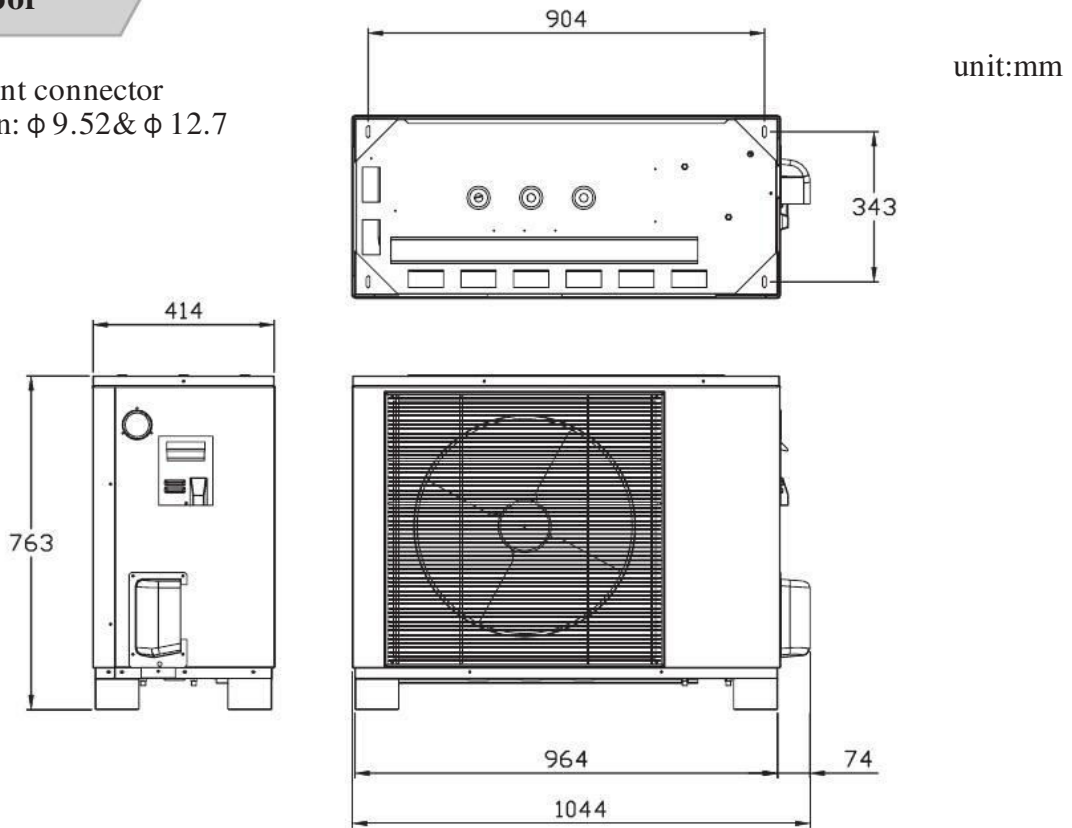

Outdoor

AW13-V5+IOU

Refrigerant connector dimension: $\phi 9.52$ & $\phi 16$

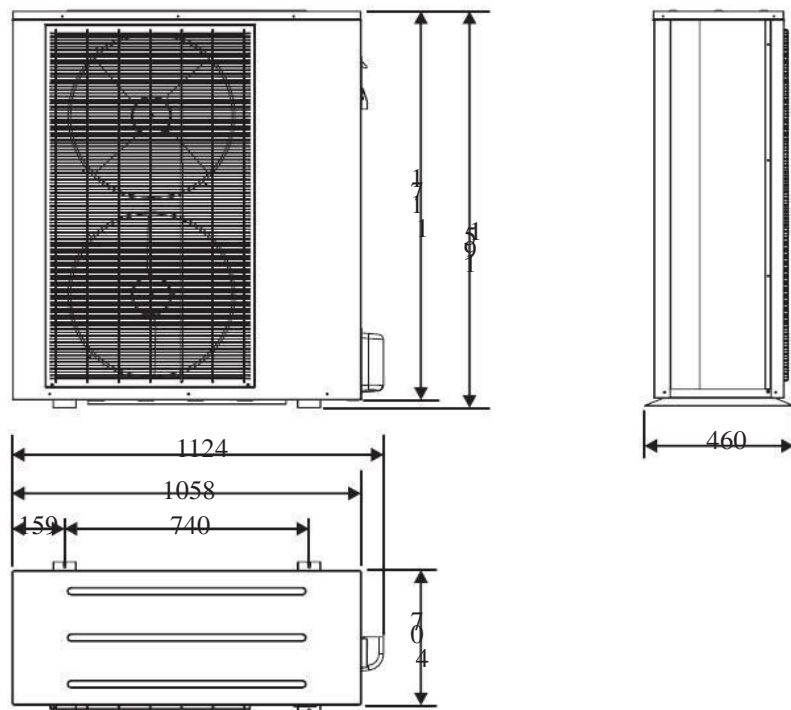

5. ATTACHED DRAWING

5.2 Exploded view

AWH9/11-V5+IIU

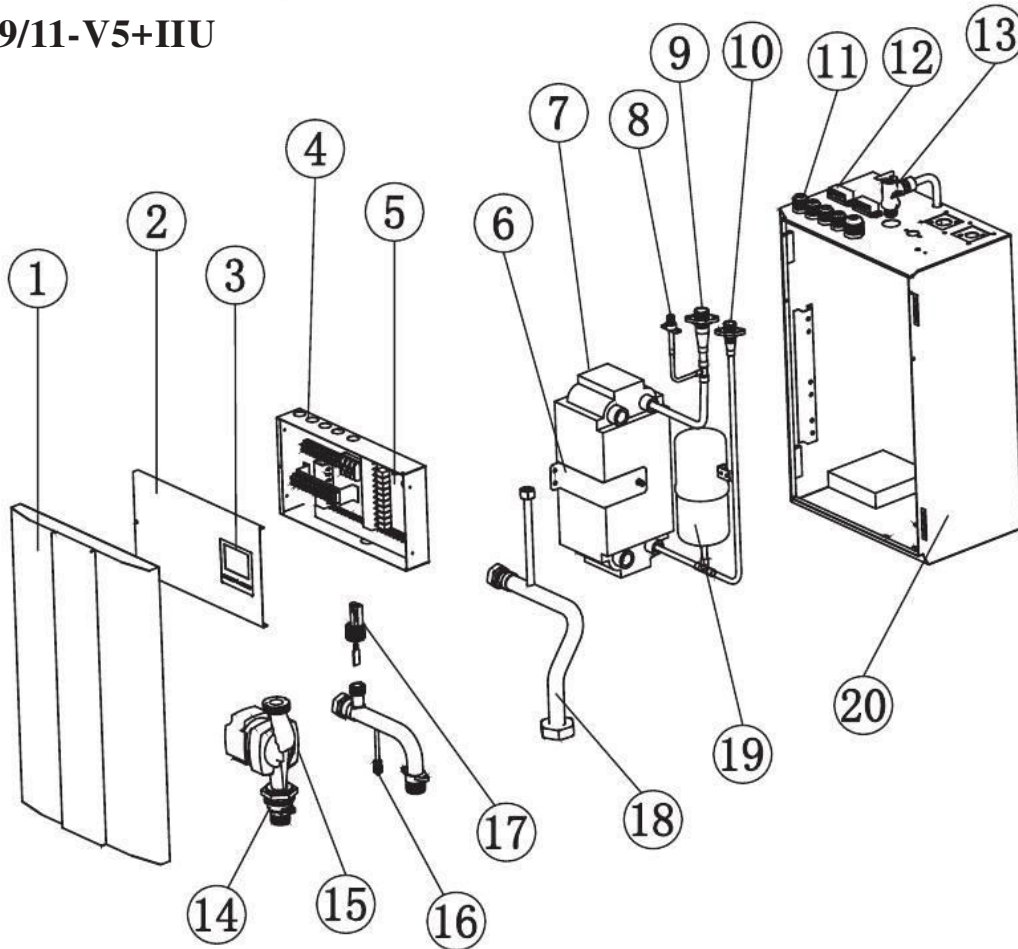

NO	Name	NO	Name
1	Front panel	16	Needle valve for drain
2	Electric box cover	17	Water flow switch
3	Wired controller	18	Water outlet pipe
4	Electric box	19	Refrigerant expansion tank
5	Indoor PCB	20	Casing
6	Fixing plate for plate heat exchanger	21	TEMP.SENSOR(COOLING)
		22	TEMP.SENSOR(HEATING)
7	Plate heat exchanger	23	TEMP.SENSOR(HOT WATER)
8	Service valve	24	TEMP.SENSOR(COIL PIPE FOR SYSTEM2)
9	1/2" valve		
10	3/8" valve	25	TEMP.SENSOR(COIL PIPE FOR SYSTEM1)
11	Cable gland		
12	Cable clip	26	TEMP.SENSOR(WATER OUTLET)
13	Pressure release valve	27	TEMP.SENSOR(WATER INLET)
14	Connector for water pump	28	TEMP.SENSOR(ROOM)
15	Water pump		

5. ATTACHED DRAWING

5.2 Exploded view

AWH13-V5+IIU

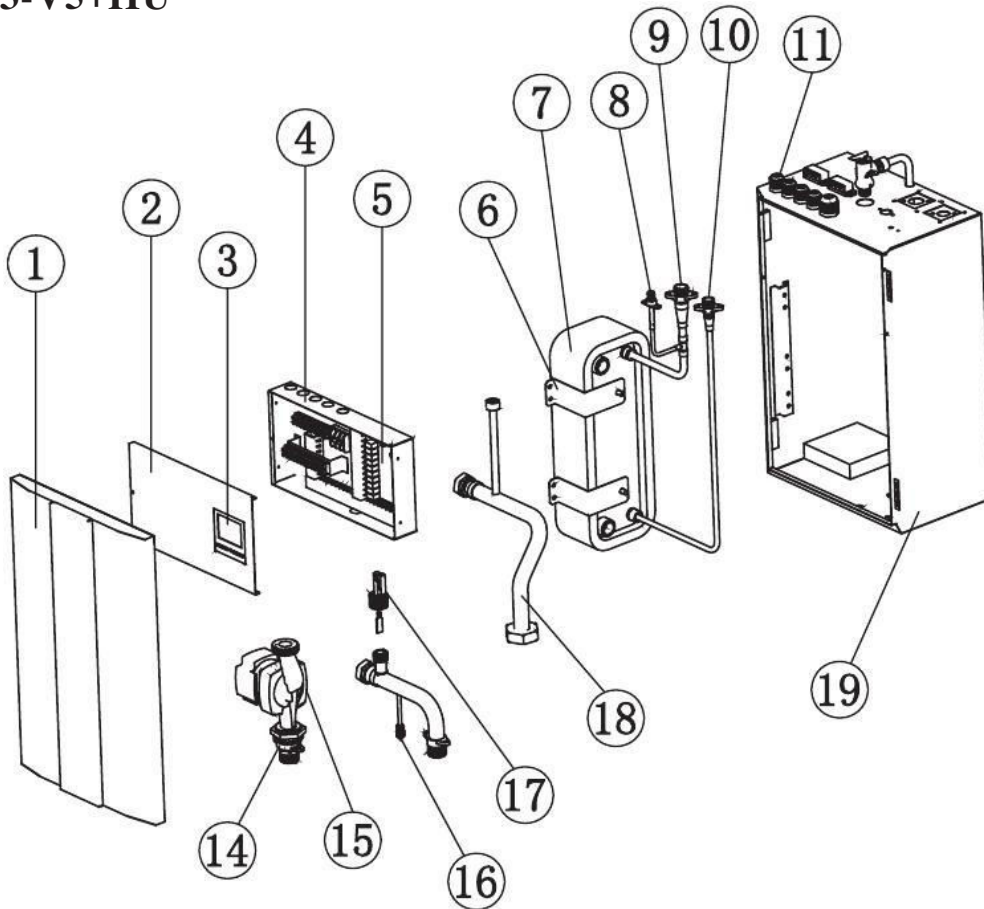

NO	Name	NO	Name
1	Front panel	16	Needle valve for drain
2	Electric box cover	17	Water flow switch
3	Wired controller	18	Water outlet pipe
4	Electric box	19	Casing
5	Indoor PCB	20	TEMP.SENSOR(ROOM)
6	Fixing plate for plate heat exchanger	21	TEMP.SENSOR(COOL)
		22	TEMP.SENSOR(HEAT)
		23	TEMP.SENSOR(HOT WATER)
7	Plate heat exchanger	24	TEMP.SENSOR(COIL PIPE FOR SYSTEM2)
8	Service valve		TEMP.SENSOR(COIL PIPE FOR SYSTEM1)
9	5/8" valve		TEMP.SENSOR(WATER OUTLET)
10	3/8" valve	25	TEMP.SENSOR(WATER INLET)
11	Cable gland		
12	Cable clip		
13	Pressure release valve		
14	Connector for water pump		
15	Water pump		

5. ATTACHED DRAWING

AW9/11-V5+IOU

Outdoor

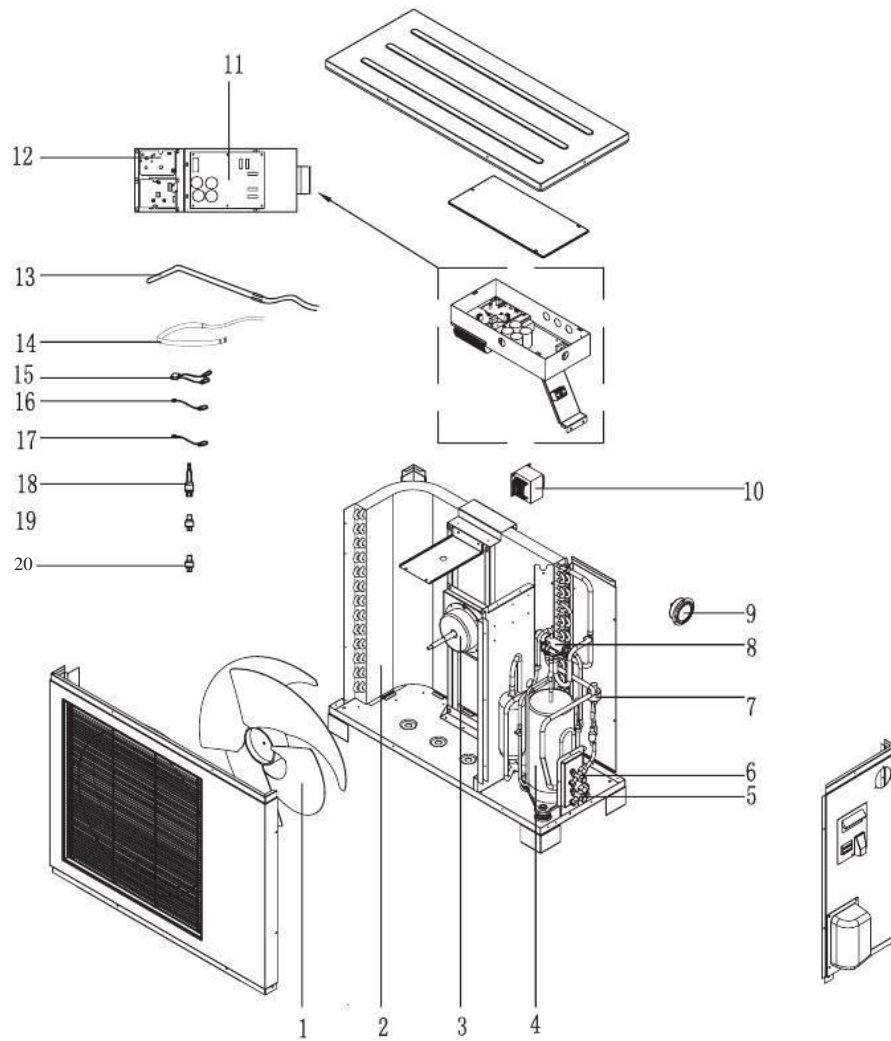

NO	Name
1	Fan
2	Condenser for 11KW Condenser for 9KW
3	DC fan motor
4	Compressor
5	1/2" connector
6	3/8" connector
7	EEV coil EEV
8	4-way valve 4-way valve coil
9	High pressure gauge
10	PFC transducer

NO	Name
11	Main Power PCB for 9KW Main Power PCB for 11KW
12	Mould board and PFC board (two small PCB)
13	Condenser heater for 11KW Condenser heater for 9KW
14	Compressor heater
15	Coil and ambient temperature sensor
16	Compressor discharge temp. sensor
17	Compressor suction temp. sensor
18	High pressure switch
19	Low pressure sensor
20	High pressure sensor

5. ATTACHED DRAWING

AW13-V5+IOU

Outdoor

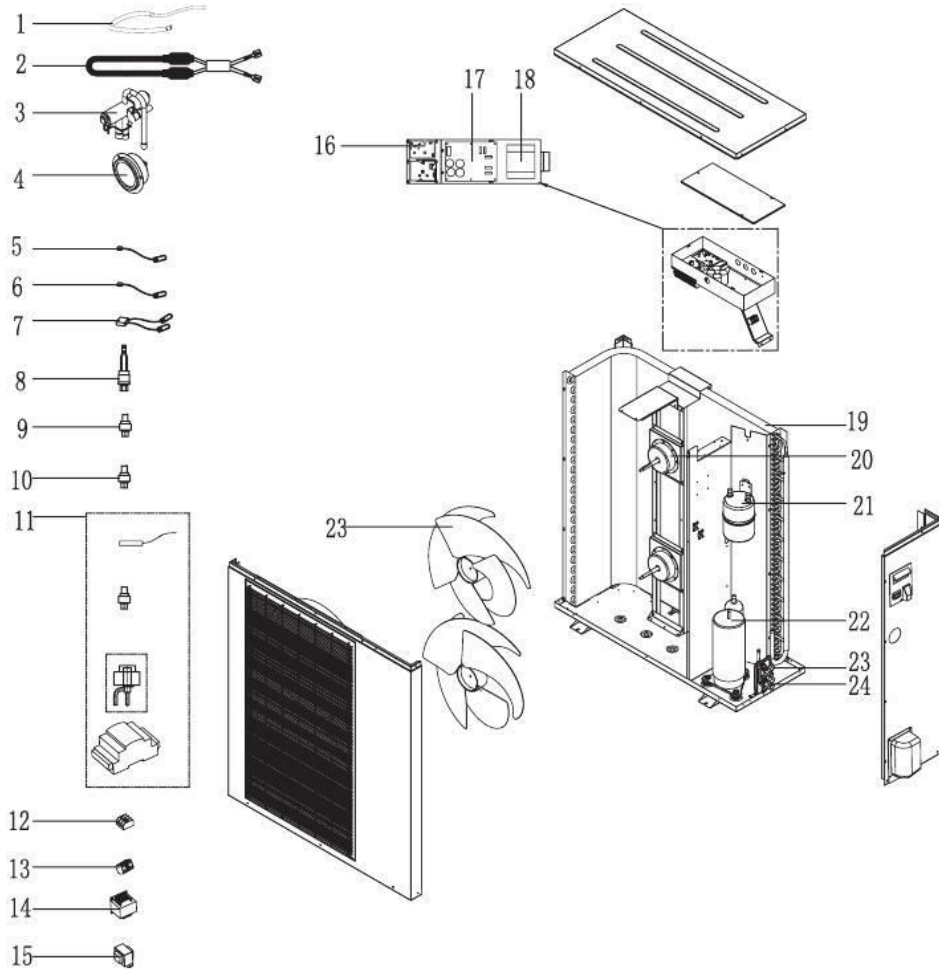

NO	Name	NO	Name
1	Compressor crankcase heater	13	Four bit terminal block
2	Condenser heater	14	PFC transducer
3	Four-way valve	15	Transformer
4	High pressure gauge	16	Mould board and PFC board(two small PCB)
5	Compressor discharge temperature sensor	17	Main Power PCB
6	Compressor suction temperature sensor	18	Fan
7	Ambient&Coil temperature sensor	19	Evaporator
8	High pressure switch	20	DC fan motor
9	Low pressure sensor	21	Gas liquid separator
10	High pressure sensor	22	Compressor
11	Electronic expansion valve+ LVD Controller	23	3/8" connector
12	Three bit Terminal block	24	5/8" connector

5. ATTACHED DRAWING

5.3 Wiring diagram

Indoor--- AWH9/11/13-V5+

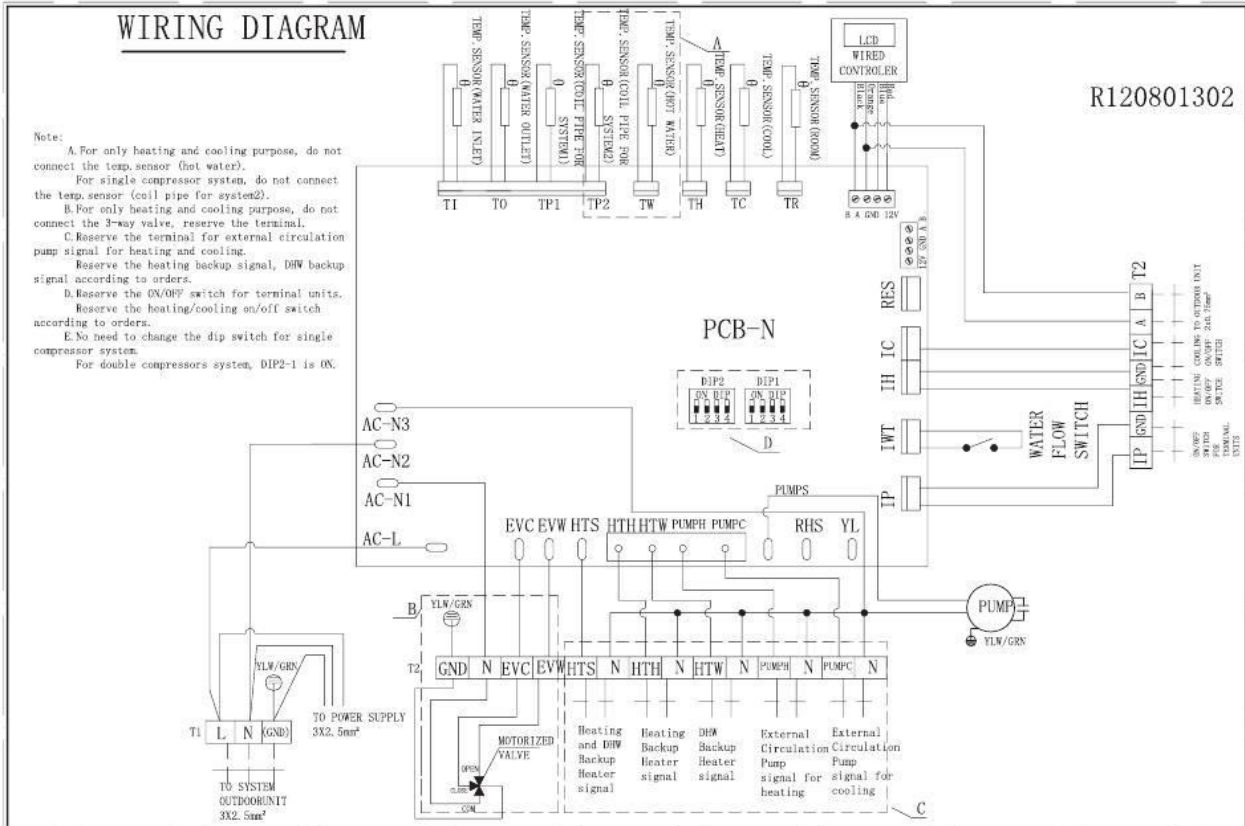

Take Care:

This diagram is subject to change with improvement of the unit. Always refer to the diagram supplied with the product.

5. ATTACHED DRAWING

Outdoor---AW9/11-V5+

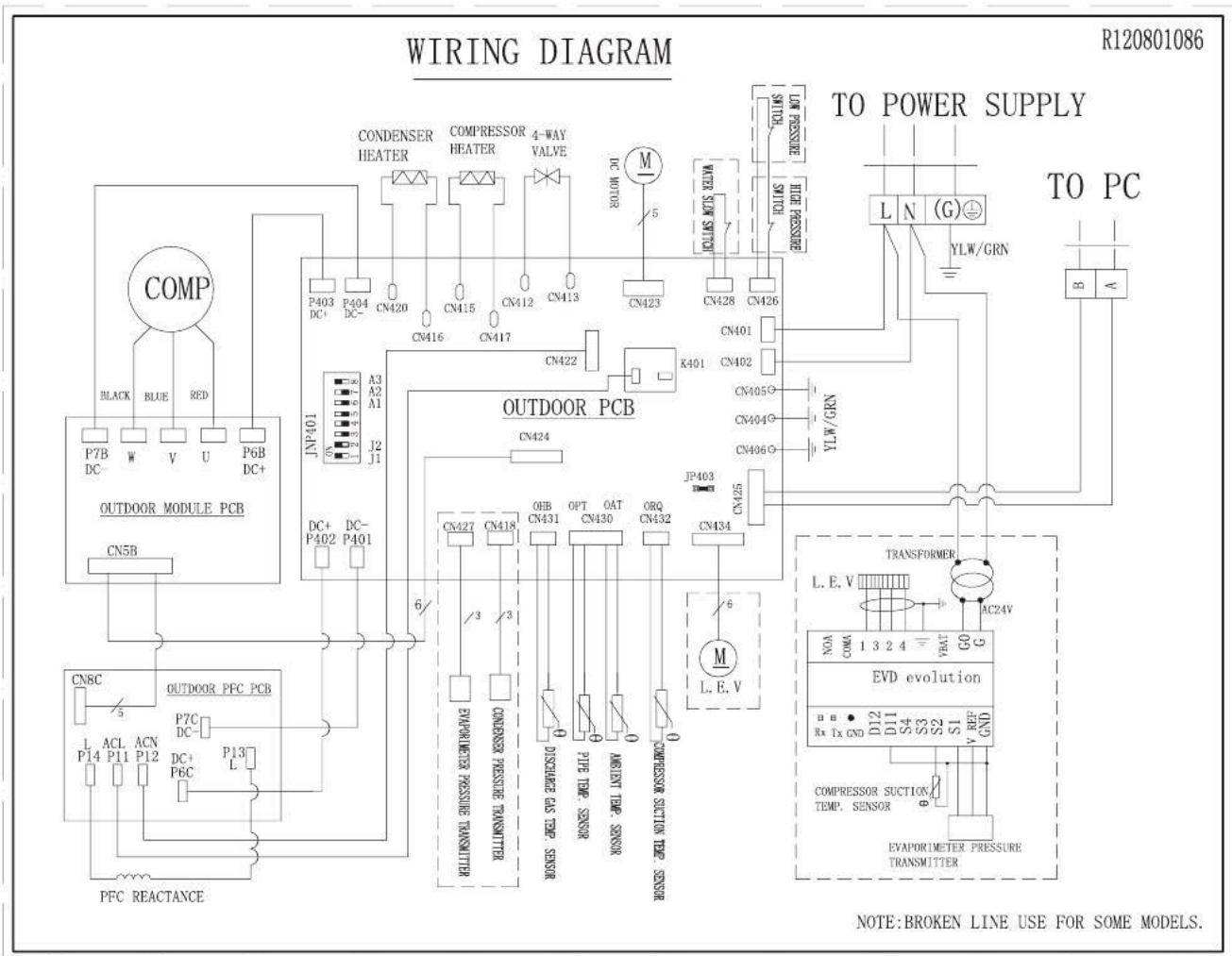

Take Care:

This diagram is subject to change with improvement of the unit. Always refer to the diagram supplied with the product.

5. ATTACHED DRAWING

Outdoor---AW13-V5+

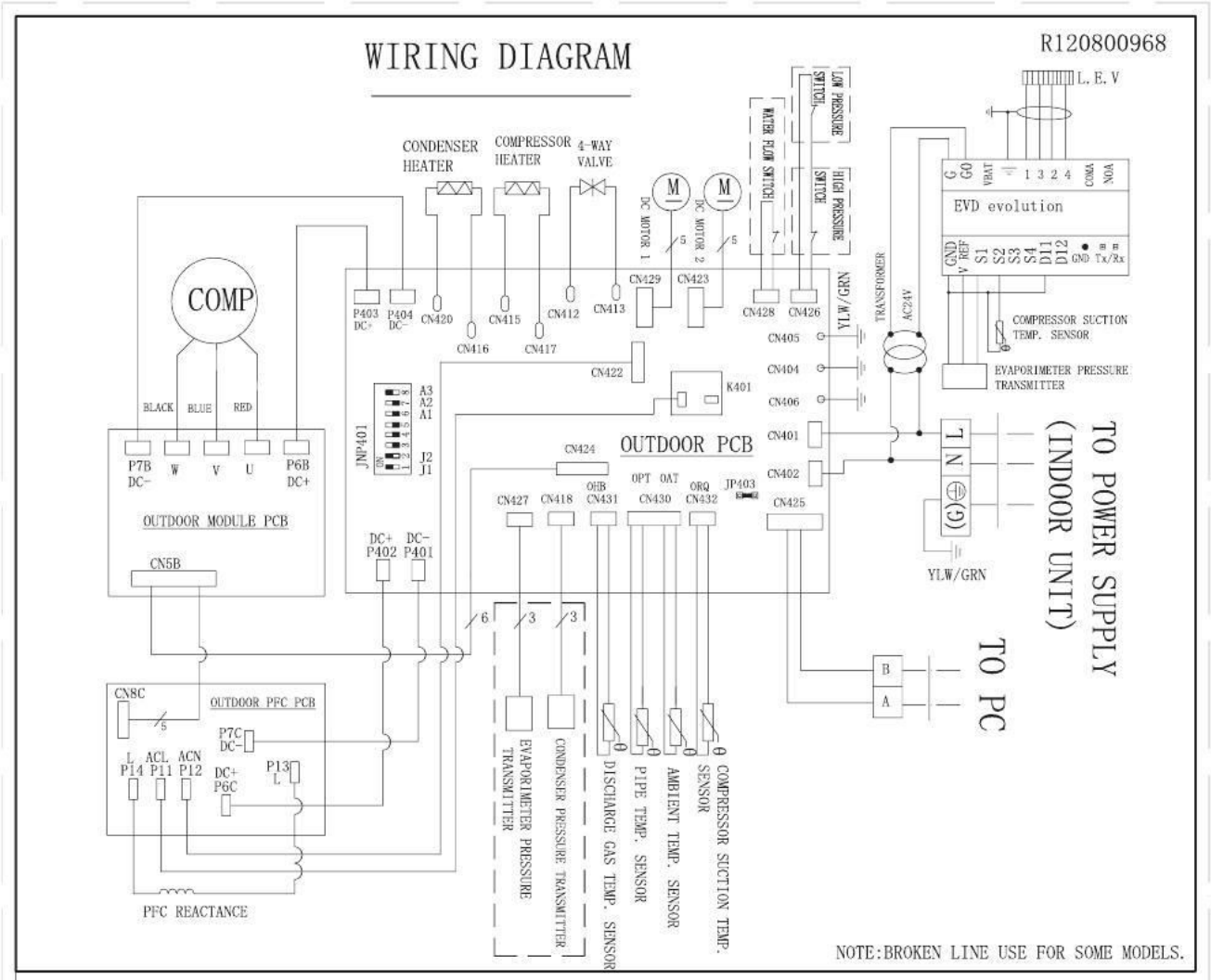

Take Care:

This diagram is subject to change with improvement of the unit. Always refer to the diagram supplied with the product.

